

Dual Joist
Ceiling Mount
24 inch

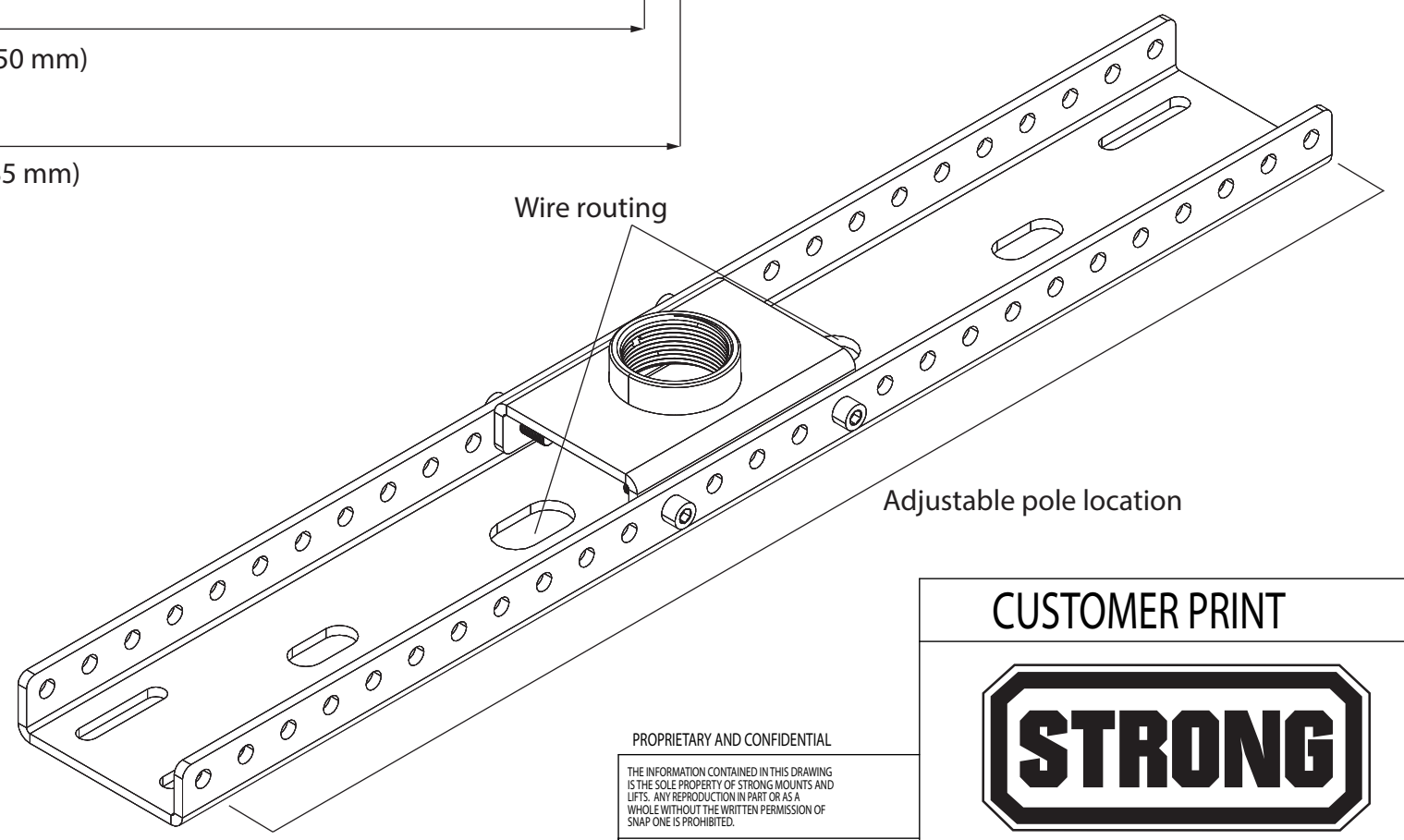

PROPRIETARY AND CONFIDENTIAL
THE INFORMATION CONTAINED IN THIS DRAWING IS THE SOLE PROPERTY OF STRONG MOUNTS AND LIFTS. ANY REPRODUCTION IN PART OR AS A WHOLE WITHOUT THE WRITTEN PERMISSION OF SNAP ONE IS PROHIBITED.

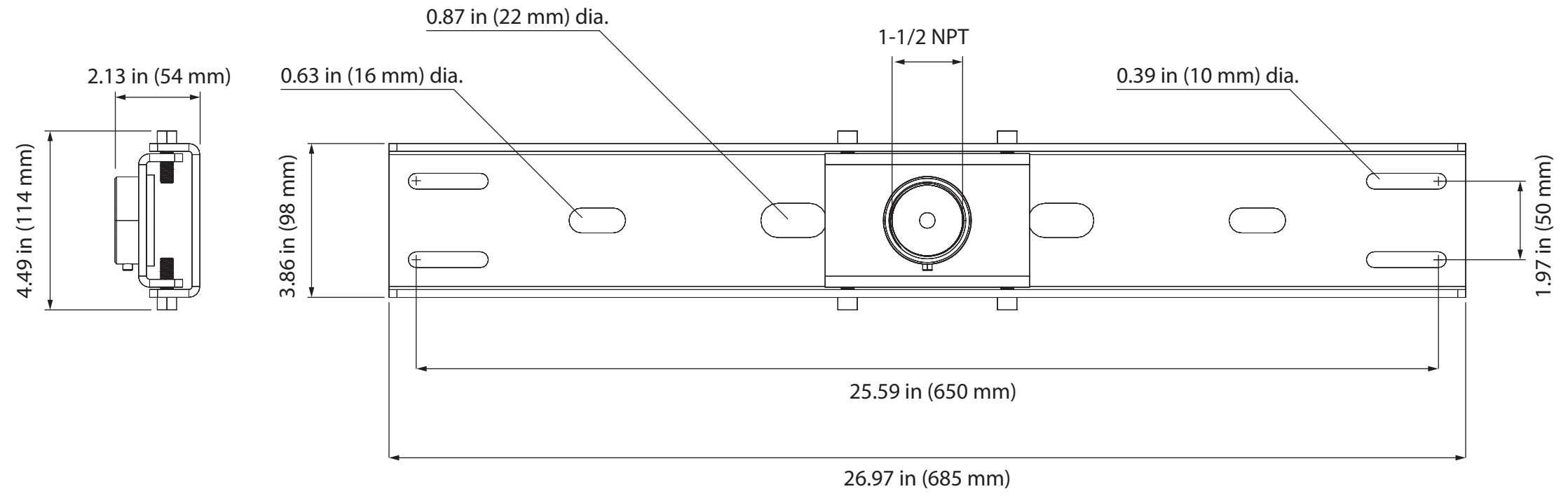
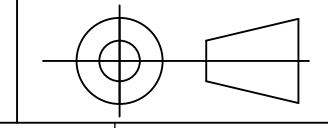

CUSTOMER PRINT		
STRONG		
SIZE B	DRAWING NUMBER SM-CB-CM-DJ-24-BLK	DWG REV A
DO NOT SCALE DRAWING		SHEET 1 of 1