

Fully insert eye bolts (Fig 4).

Solid Concrete:

Drill 1/4" (6 mm) diameter holes 1.5" (38 mm) deep. Hammer in Concrete Anchors (Fig 5).

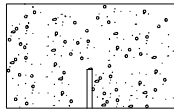

Fig 5

Truss Ceiling:

No anchor required. After attaching Tie Wire to Turnbuckle, loop upper end around ceiling truss. Pull Tie Wire tight and twist it around itself several times (minimum of 6-8 times recommended) as tightly as possible (Fig 6).

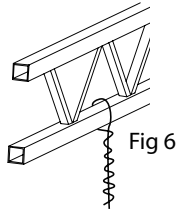

Fig 6

Position the holes so when the Tie Wires are attached and taut, the optimal angle is 15°. Unit may be mounted at an angle up to 45° if necessary.

- e. Pull Tie Wires tight and attach to ends of ceiling anchors. Twist each wire around itself several times (minimum of 6-8 times recommended) as tightly as possible. The weight of the Ceiling Tray should be supported by the Tie Wires.

Note: 20' (6.1 m) of Tie Wire is provided. If space between the true ceiling and suspended ceiling is more than 36" (914 mm), additional wire (12 gauge annealed, steel, black) will be needed.

DO NOT extend two wires together - use one continuous wire.

Step 4: Install Extension Pole (optional)

- a. If installed, remove the Flush Mount Tube.
- b. From the bottom up, thread Extension Column (not included) up through Retaining Collar in Adjustable Collar Mount Plate. Fasten with a Set Screw using the Allen Wrench (Fig 7).

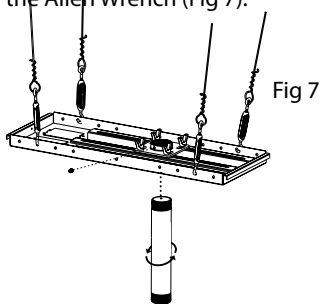

Fig 7



Find details of this product's Lifetime Limited Warranty at snapav.com/warranty, or request a paper copy from Customer Service at (866) 424-4489. Find other legal resources, such as regulatory notices and patent information, at snapav.com/legal.

Copyright ©2020, Wirepath Home Systems, LLC. All rights reserved. Control4 and SnapAV and their respective logos are registered trademarks or trademarks of Wirepath Home Systems, LLC, dba "Control4" and/or dba "SnapAV" in the United States and/or other countries. 4Store, 4Sight, Control4 My Home, Snap AV, Arakis Networks, BakPak, Binary, Dragonfly, Episode, Luma, Mockupancy, Nearus, NEEQ, Optiview, OvrC, Pakedge, Sense, Strong, Strong Evolve, Strong Versabox, SunBriteDS, SunBriteTV, Triad, Truvison, Visualint, WattBox, Wirepath, and Wirepath ONE are also registered trademarks or trademarks of Wirepath Home Systems, LLC. Other names and brands may be claimed as the property of their respective owners. All specifications subject to change without notice.

For Technical Support call 1.866.838.5052

201202-0934 TW

SM-CEILING-SCA-WH

Strong™ Suspended Ceiling Tile Adapter Plate (White)



engineered by
Snap
av

PARTS INCLUDED

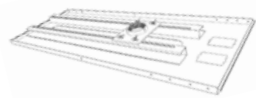

Ceiling Tray (x1)



Allen Wrench, 2.5mm, Security/Non-Security (x1)



Tie Wire, 20' (x1)



Flush Mount Tube (x1)



Concrete Anchor (x4)

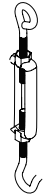

Turnbuckle (x4)



Eye Bolt (x4)

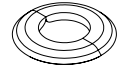

Escutcheon (x1)



M5 x 5mm Set Screw, Security (x2)



M5 x 5mm Set Screw (x2)

WARNINGS

- Installation by a qualified professional is highly recommended.
- Do not begin installation until these instructions have been thoroughly read and understood.
- This ceiling plate supports a maximum load of 100 lbs (45.5 kg).
- The manufacturer does not accept responsibility for incorrect installation.

TOOLS REQUIRED

- Power Drill
- 5/32" (4mm) Drill bit
- 1/4" (6mm) Masonry Bit
- 13/32" Socket Head Wrench

INSTALLATION INSTRUCTIONS

Important Pre-Assembly Information:

The Ceiling Tray is designed to fit above a 24" (610 mm) x 24" (610mm) or 24" (610mm) x 48" (1220mm) conventional suspended ceiling. Ceiling runners should have a "T" cross-section and a minimum height of 1.5" (38 mm).

For certain installations, ceiling anchors may need to be installed (Step 3) before the ceiling tray (Step 1).

Step 1: Install the Ceiling Tray

- Place the Ceiling Tray in the grid above a 24" x 24" or 24" x 48" false ceiling tile so that lip of Ceiling Tray rests on ceiling runners (Fig 1).
- Slide Collar Mount Plate to desired position. Using hole in Collar Mount Plate, mark the ceiling tile where the hole will be cut. Remove Ceiling Tray and cut out a 2.25" hole in ceiling tile. Slide Collar Mount Plate back into position over cut hole and tighten all Wing Nuts.

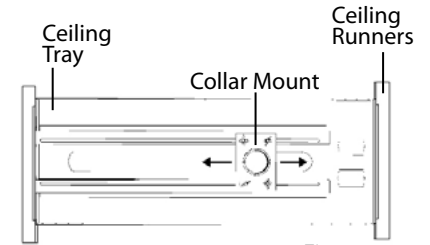

Fig 1

Step 2: Install the Flush Mount Tube

- From the top, thread the Flush Mount Tube through Retaining Collar in Ceiling Tray and through the Ceiling Tile (Fig 2). Tighten the Set Screw.
- Add Eschutchen ring for a more finished look.

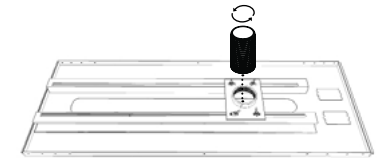

Fig 2

Step 3: Install the Wire Supports

- Insert Turnbuckle hooks into four corners of Ceiling Tray (Fig 3).
- Cut Tie Wire into four pieces of equal length and insert wires through the ends of the Turnbuckles.
- Twist each wire around itself several times (minimum of 6-8 times recommended) as tightly as possible.
- Drill holes for four Ceiling Anchors based on material:

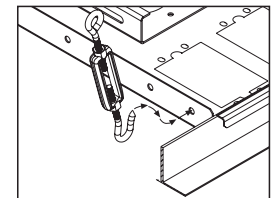

Fig 3



Fig 4

Wood Joists or Beams:

Drill 5/32" (4 mm) diameter holes 2" (51 mm) deep.

(Continued on back)