

FTI-STK1: Vehicle Coverage and Preparation Notes

Make	Model	Year	Install	CAN	IMMO	BCM	Clutch	I/O Changes
DL-SUB9 Subaru	Forester STD KEY AT (Canada)	2019-23	Type 2	40-Pin	Type B	DSD	N/A	Green White/Blue N/A

Covered vehicle use **BLADE-AL-SUB9** firmware and the following required accessories, Weblink Hub & ACC RFID1. Flash module, and update the controller firmware. **Please follow the directions for RFID programming before attempting to program the BLADE module to the vehicle.**

CAN: Type 2 CAN connections are made using the 40-Pin BCM connector and require connecting the white 2-pin female connector to the black male 2-pin connector at marker [D] of the illustration.

Immobilizer: Type B IMMO requires connecting the black and white 2-pin connectors at marker [C] of the illustration.

Lights: Parking lights are pre-wired in the FTI-STK1 harness. Replace the green/white wire of the CM I/O connector with the pre-terminated green/white wire of the harness.

ACC-RFID1 (REQUIRED): SUB9 firmware does not provide immobilizer data, an ACC-RFID1 is therefore required for remote start

2nd START: The FTI-STK1 harness is pre-wired with a red/white 2nd START output (not required in TYPE 2), cut and insulate the provided wire to prevent short circuits when not used.

I/O Changes: None required

Advisory 1: Program ACC-RFID1 before attempting to program the BLADE module to the vehicle.

Advisory 2: Secure all 2-pin connections, both used and unused, to the main harness body.

FTI-STK1: Installation and Configuration Notes

- A** REQUIRED ACCESSORY
- B** ADAPTER NOT REQUIRED
- C** REQUIRED CONFIGURATION (TYPE B IMMO)
- D** REQUIRED CONNECTION
- E** NO CONNECTION

•FT-DAS Required for manual transmission.
•BOTH Red & Red/White MUST be connected with high current application.

Jumper Setting

CM7000/7200 **Cut loop for A/T**

CM900AS/900S Jumper



FEATURE COVERAGE															
IMMOBILIZER DATA	ARM OEM ALARM	DISARM OEM ALARM	DOOR LOCK	DOOR UNLOCK	PRIORITY UNLOCK	TRUNK/HATCH RELEASE	TACH OUTPUT	DOOR STATUS	TRUNK STATUS	BRAKE STATUS	E-BRAKE STATUS	A/M ALRM CONTROL FROM OEM REMOTE	A/M RS CONTROL FROM OEM REMOTE	AUTOLIGHT CTRL	

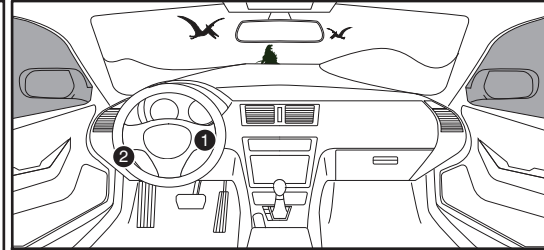
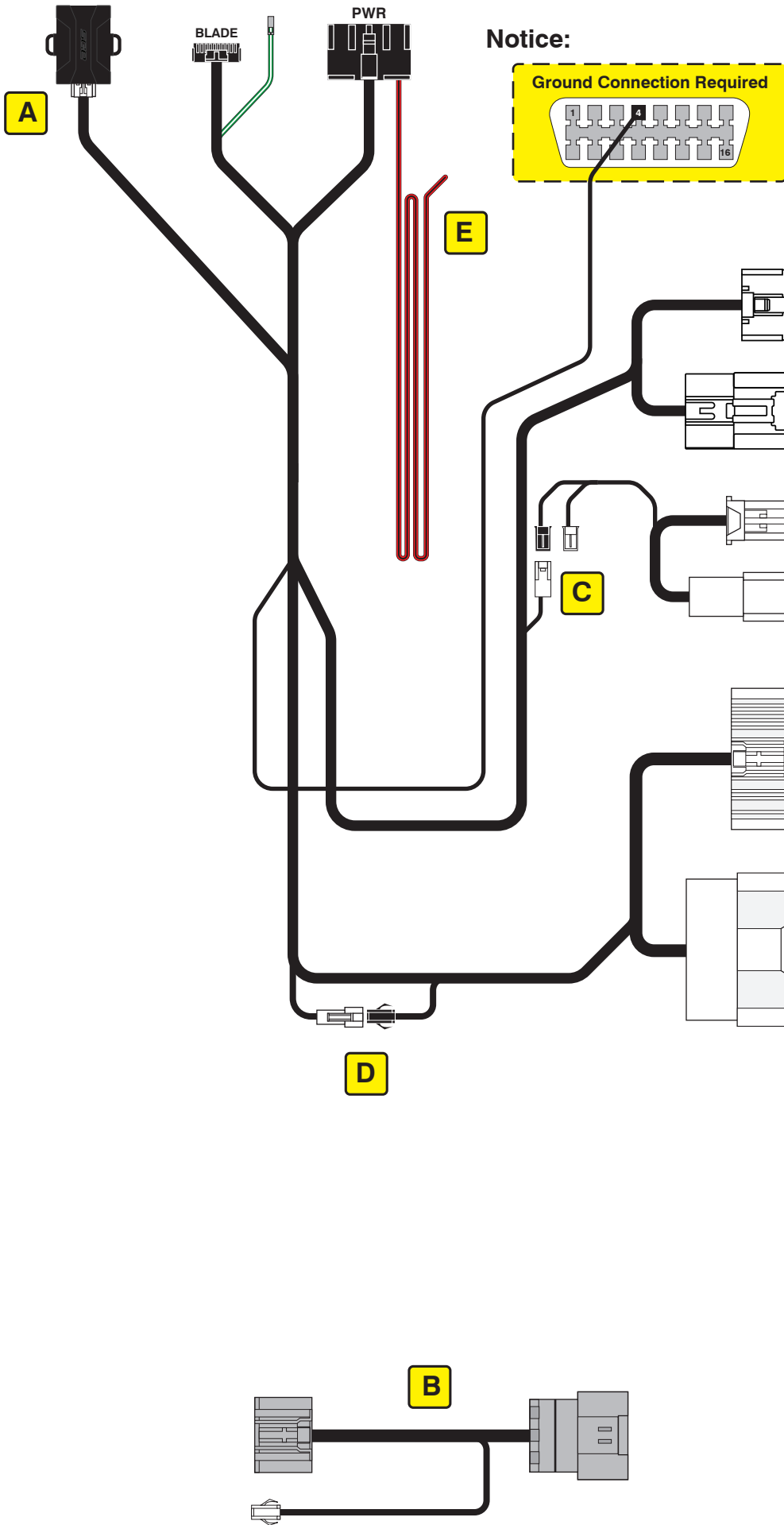

Ignition Switch Assembly

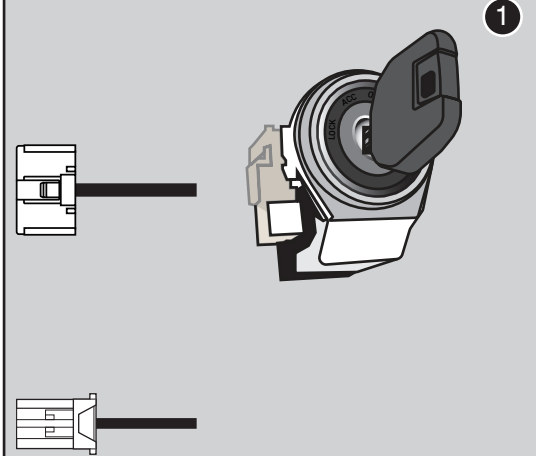

BCM/Fuse Box

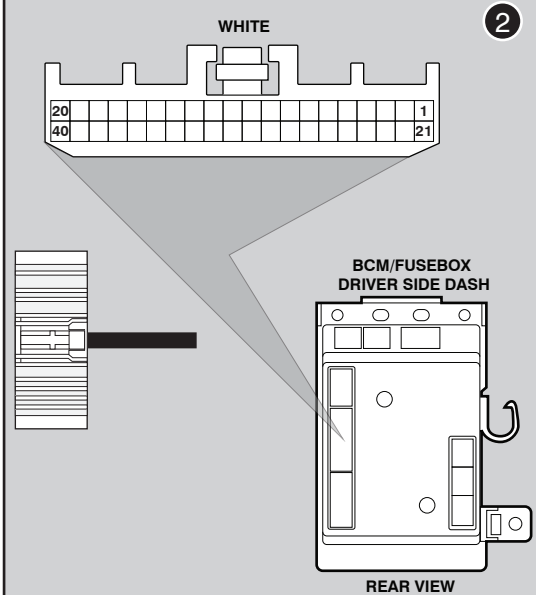

LED Programming Error Codes

Module LED flashing RED during programming

- 1x RED = Unable to communicate with RFID or immobilizer data.
- 2x RED = No CAN activity. Check the CAN wire connections.
- 3x RED = No ignition detected. Check the ignition wire connection and CAN.
- 4x RED = Required ignition output diode not detected.

CARTRIDGE INSTALLATION

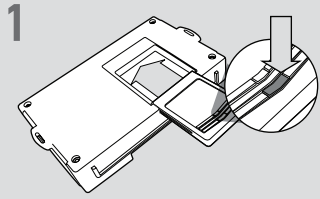

1 Slide cartridge into unit. Notice button under LED.

2 Ready for Module Programming Procedure.

MODULE PROGRAMMING PROCEDURE



1 For this installation, the Weblink HUB is required.



2 Remove OEM key 1 from keychain.

! Place all other keyfobs at least 1 foot away from the Weblink HUB. Failure to comply may result in damage to other keyfobs or interfere with the keyfob reading process.



3 Flash the module using the Weblink HUB. Follow the on screen instructions to complete the keyfob reading process.

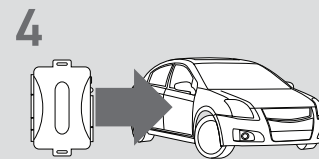

4 **WARNING:**
Do not press the module programming button.
Connect power first.
Connect module to vehicle.



5 Using OEM key 1, turn key to ON position.

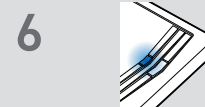

6 Wait, LED will turn solid BLUE for 2 seconds .



7 Turn key to OFF position.

8 Module Programming Procedure completed.