

episode[®]
commercial

engineered by
Snap
av

OWNER'S MANUAL

ECA COMMERCIAL AMPLIFIER

ECA-70MIXAMP-1-240

100V / 70V / 50V / 4Ω Amplifier

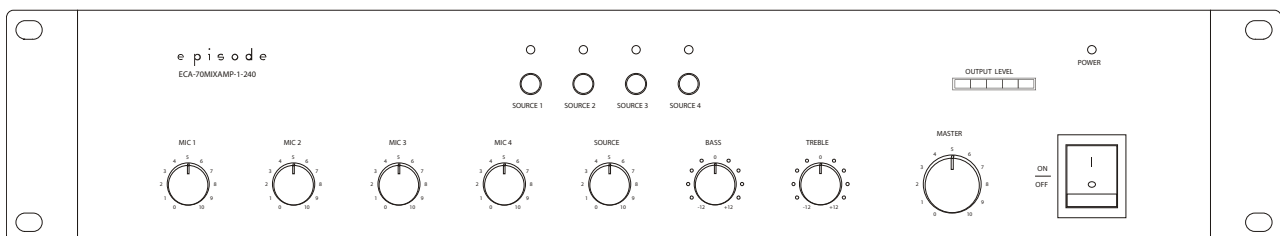

Important Safety Instructions

WARNING: To reduce the risk of fire or electric shock, do not expose this apparatus to rain or moisture.

1. Read and follow all instructions and warnings in this manual. Keep for future reference.
2. Do not use this apparatus near water.
3. Clean only with a dry cloth.
4. Do not block any ventilation openings. Install according to manufacturer's instructions.
5. Do not install near any heat sources such as radiators, heat registers, stoves or other apparatus (including amplifiers) that produce heat.
6. Do not override the safety purpose of the polarized or grounding-type plug. A polarized plug has two blades - one wider than the other. A grounding type plug has two blades and a third grounding prong. The wide blade or the third prong is provided for your safety. If the provided plug does not fit into your outlet, consult an electrician for replacement of the obsolete outlet.
7. Protect the power cord from being walked on or pinched particularly at plug, convenience receptacles, and the point where it exits from the apparatus.
8. Only use attachments/accessories specified by the manufacturer.
9. Use only with a cart, stand, tripod, bracket or table specified by the manufacturer, or sold with the apparatus. When a cart is used, use caution when moving the cart/apparatus combination to avoid injury from tip-over.
10. Unplug this apparatus during lightning storms or when unused for long periods of time.
11. Refer all servicing to qualified service personnel. Servicing is required when the apparatus has been damaged in any way, such as when the power-supply cord or plug is damaged, liquid has been spilled or objects have fallen into the apparatus, the apparatus has been exposed to rain or moisture, does not operate normally, or has been dropped.
12. DO NOT EXPOSE THIS EQUIPMENT TO DRIPPING OR SPLASHING AND ENSURE THAT NO OBJECTS FILLED WITH LIQUIDS, SUCH AS VASES, ARE PLACED ON THE EQUIPMENT.
13. TO COMPLETELY DISCONNECT THIS EQUIPMENT FROM THE AC MAINS, DISCONNECT THE POWER SUPPLY CORD PLUG FROM THE AC RECEPTACLE.
14. THE MAINS PLUG OF THE POWER SUPPLY CORD SHALL REMAIN READILY OPERABLE.

CAUTION: TO REDUCE THE RISK OF ELECTRICAL SHOCK, DO NOT REMOVE COVER. NO USER SERVICEABLE PARTS INSIDE. REFER SERVICING TO QUALIFIED SERVICE PERSONNEL.



The lightning flash with arrowhead symbol, within an equilateral triangle, is intended to alert the user to the presence of un-insulated dangerous voltage within the product's enclosure that may be of sufficient magnitude to constitute a risk of electric shock to persons.



The exclamation point within an equilateral triangle is intended to alert the user to the presence of important operating and maintenance (servicing) instructions in the literature accompanying the appliance.

Consignes de Sécurité Importantes

Avertissement: Pour réduire le risque d'incendie ou un choc électrique, ne pas exposer cet appareil à la pluie ou à l'humidité.

1. Lisez et suivez toutes les instructions et les avertissements contenus dans ce manuel. Conserver pour référence ultérieure.
2. Ne pas utiliser cet appareil près de l'eau.
3. Nettoyez uniquement avec un chiffon sec.
4. Ne pas bloquer les ouvertures de ventilation. Installez selon les instructions du fabricant.
5. Ne pas installer près de sources de chaleur telles que des radiateurs, registres de chaleur, poêles ou autres appareils (incluant les amplificateurs) qui produisent de la chaleur.
6. Ne pas remplacer le dispositif de sécurité de la fiche polarisée ou de terre. Une fiche polarisée possède deux lames - une plus large que l'autre. Une fiche de terre a deux lames et une troisième broche de terre. Les larges lames ou la troisième broche est fournie pour votre sécurité. Si la fiche fournie ne rentre pas dans votre prise, consultez un électricien pour remplacer la prise obsolète.
7. Installez le cordon d'alimentation pour qu'il ne soit pas piétiné ou pincé, en particulier au bouchon, réceptacle commode, et au point où il sort de l'appareil.
8. Utiliser uniquement les fixations / accessoires spécifiés par le fabricant
9. Utilisez uniquement avec un chariot, stand, trépied, support ou table spécifié par le fabricant ou vendu avec l'appareil. Lorsque vous utilisez un chariot, soyez prudent lorsque vous déplacez l'ensemble chariot / appareil pour éviter les blessures en cas de chute.
10. Débranchez cet appareil pendant la foudre donne l'assaut à ou si inutilisé pendant de longues périodes.
11. Référez-vous tous qui entretiennent au personnel de service qualifié. L'entretien est exigé quand l'appareil a été endommagé de quelque façon, comme quand puissance-fournissez la corde ou la prise est endommagé, on a renversé le liquide ou les objets sont tombés dans l'appareil, l'appareil a été exposé à la pluie ou à l'humidité, ne fonctionne pas normalement, ou a été lâché.
12. N'exposez pas cet équipement à l'égoutture ou éclaboussant et s'assurer qu'objet n'a pas rempli de liquides, tels que des vases, sont placés sur l'équipement.
13. Pour démonter complètement cet équipement des forces à C.A., démontez la prise de cordon de secteur du réceptacle à C.A.
14. La prise de forces de corde d'alimentation d'énergie restera ready fonctionnelle.

ATTENTION : POUR RÉDUIRE LE RISQUE DE CHOC ÉLECTRIQUE, N'ENLEVEZ PAS LA COUVERTURE. AUCUN INTÉRIEUR UTILE DE PIÈCES D'UTILISATEUR NE SE RÉFÈRENT L'ENTRETIEN AU SERVICE QUALIFIÉ PERSONNEL.

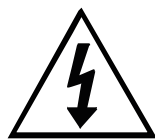

Le flash de foudre avec le symbole de pointe de flèche, dans une triangle équilatérale, est prévu pour alerter l'utilisateur à la présence de la tension dangereuse non isolée dans la clôture du produit qui peut être de la grandeur suffisante pour constituer un risque de décharge électrique aux personnes.



Le point d'exclamation dans une triangle équilatérale est prévu pour alerter l'utilisateur à la présence des instructions importantes de fonctionnement et d'entretien (entretien) dans la littérature accompagnant l'appareil.

Table of Contents

Important Safety Instructions	2
Overview	5
Features	5
Front Panel	6
Rear Panel	7
Installation	8
Positioning the Amplifier	8
Rack Mounting	8
Standard Connections	9
XLR Pinouts	9
Speaker Connections	9
Advanced Connections	10
External Audio Processing	10
Cascading Amplifiers	11
Specifications	12
Troubleshooting	13
Contacting Technical Support	14
Warranty	14

Overview

Episode® is one of the most highly-regarded brands of amplifiers available today. We appreciate your business and we stand committed to providing our customers with the highest degree of quality and service in the industry.

The Episode® ECA-70MIXAMP-1-240 Commercial Amplifier Mixer is a superb choice for a variety of commercial applications requiring paging and multi-source background music. It has been designed with advanced mixing features and produces 240W RMS, providing the best value and quality for your commercial audio needs.

Features

- 240 Watts RMS, 1 Channel
- AC and DC power options
- Low-Frequency filter protection
- Power level meter
- Detachable locking output connector for secure easy connections
- (4) Selectable Source inputs
- Optional 2 or 4 tone chimes triggered by a contact closure
- Preamp output for signal processing equipment or additional amplification
- Individual input volume and master volume
- Current limiter, short circuit and thermal protection
- (4) Balanced XLR microphone inputs with selectable priority and phantom power options
- Constant Voltage Options, 100V, 70V and 50V
- 4 or 8 Ohm speaker output capable
- Fixed Level Rec Output

Front Panel

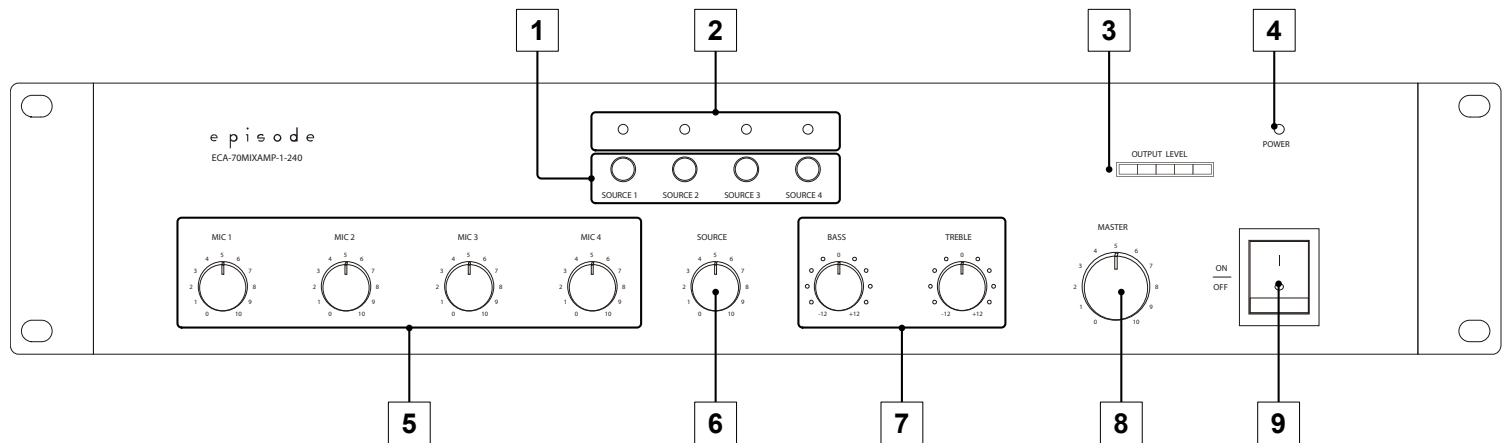

1. **Source Selection Buttons**
Direct Selection of sources.
2. **Source LEDs**
Indicates active signal from appropriate source.
3. **Output Level Meter**
Master volume output level.
4. **Power LED**
BLUE – Amplifier is On.
RED – Amplifier is in Protection.
5. **Microphone Gain Controls**
Independent gain for the appropriate microphone.
6. **Source Gain Control**
Gain for selected source connected to the amplifier.
7. **Bass / Treble Adjustments**
Adjusts the tone for the amplifier output.
8. **Master Volume Control**
Controls the output for the amp from all sources and microphones.
9. **Power Switch**
Toggle power on and off

Rear Panel

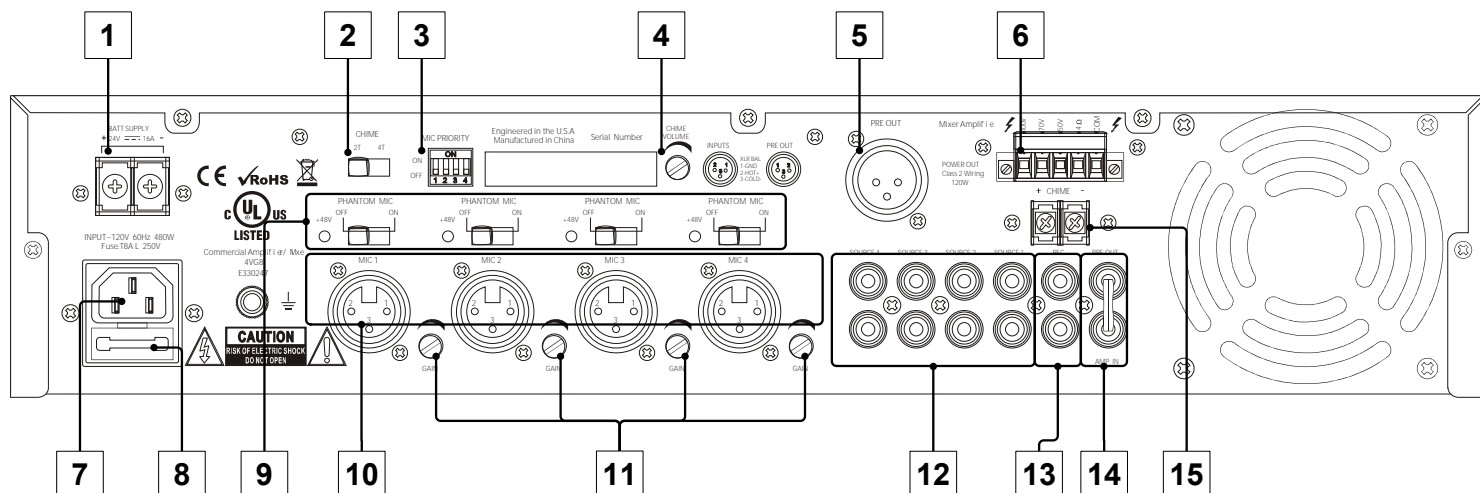

1. Optional 24V DC Power Input

Connect to a 24V DC power supply.

2. Chime Selection Switch

Sets the amount of chimes heard when the Chime Trigger is activated. 2 times or 4 times.

3. Microphone Priority Dipswitch

Sets mic ducking for the 4 Mic inputs.

- On Mic signal overrides sources. (Source signal interrupted by Mic Signal.)
- Off Mic signal mixes with sources. (Source signal and Mic Signal output simultaneously.)

4. Chime Volume

Sets the volume level of when Chimes are triggered.

5. XLR Pre Out

Balanced XLR output attenuated by Master Volume control.

Note: Output level is effected by Source and Mic gain, and Bass and Treble controls.

6. Speaker Output Connector

Connections for 50V, 70V, 100V, or 4Ω speakers attenuated by Master Volume.

Note: Output level is effected by Source and Mic gain, and Bass and Treble controls.

7. IEC Power Cord

Detachable power for amplifier.

8. AC Fuse

Replaceable main power fuse.

9. Phantom Power Switches

- Off Unpowered Mic.
- On Provides phantom power to microphones with this capability.

10. Microphone 1-4

Balanced XLR input for microphones.

11. Microphone Gain Controls

Sets the gain level for the appropriate mic input.

12. Source Inputs

Unbalanced RCA stereo input for audio sources.

13. Rec Line Output

Unbalanced RCA stereo fixed level output.

Note: Output level is effected by Source and Mic gain, and Bass and Treble controls.

14. Pre Out / Amp In

Unbalanced RCA mono output and input attenuated by Master Volume control. Jumper can be removed for use with External Audio Processor.

Note: Output level is effected by Source and Mic gain, and Bass and Treble controls.

15. Chime Remote Trigger

Connect the output of a door or other triggering source

Installation

Positioning the Amplifier

Episode amplifiers are designed to help deliver a great audio experience that makes your music come alive for years to come. However, where you place the amplifier can have a large effect on the performance that you receive and the life of the unit.

- Be sure that the unit is in a well-ventilated area that provides adequate cooling.
- Do not block the cooling vents located on both sides of the unit.
- Do not place the unit on carpeting or any similar material.
- Do not install the unit near a source of heat, or in an extremely humid or wet location.
- If your installation lacks good air flow (such as solid cabinet doors or wall-mounted racks), it may be necessary to create ventilation to allow outside air into the space.
- Allow a minimum of 5" of free air space above the unit.
- Allow a minimum of 3" of free air space on either side of the unit. (Does not apply to rack mounting)

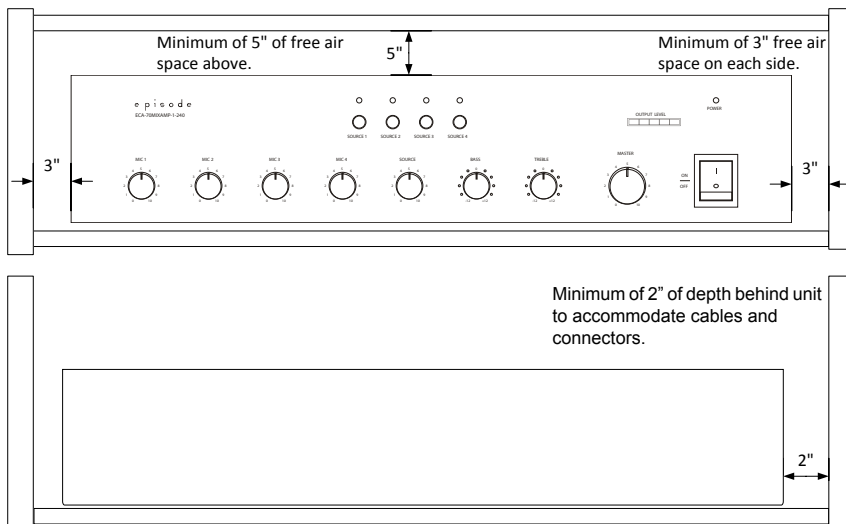

Rack Mounting

1. Remove the amplifier's four feet from the bottom of the chassis.

Note: DO NOT place the screws back into the chassis. Without the feet, the length of the screw may touch internal components and affect the performance of the amplifier.

2. Attach the included rack-mount ears to the front sides of the amplifier chassis.
3. Securely mount the amplifier into an equipment rack. The amplifier will occupy 2U of rack space.
4. Even though the amplifier produces very little heat, it is always wise to leave ventilation between components.

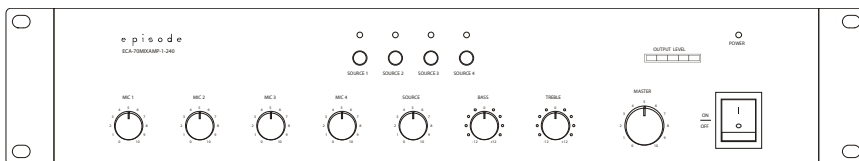

Standard Connections

While the ECA-70MIXAMP-1-240 can be used in a variety of configurations, the diagram below shows the basic application.

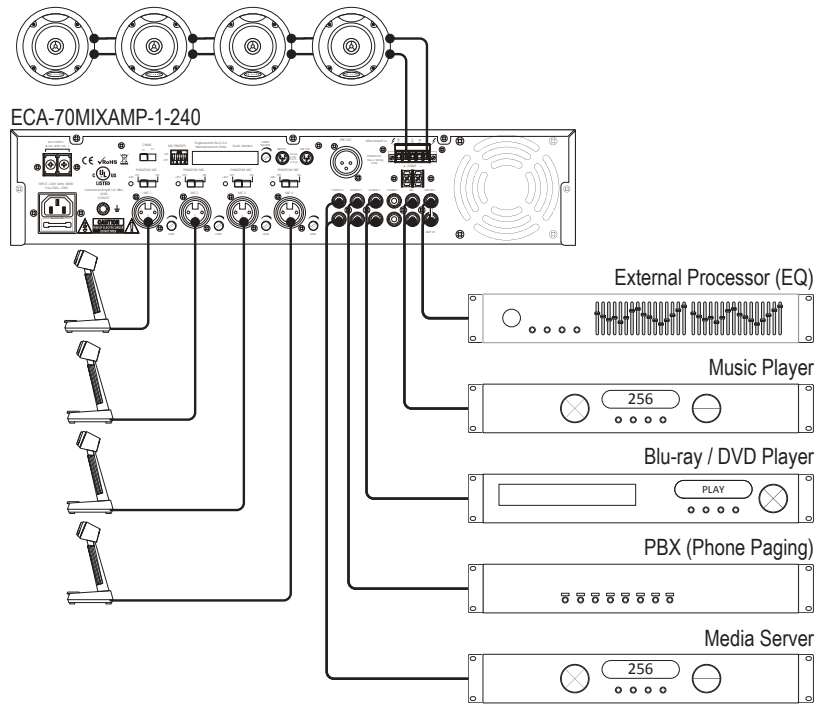

XLR Pinouts

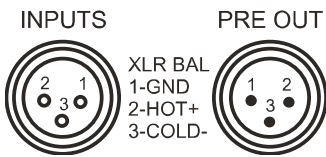

Speaker Connections



Important Note:

- The 4Ω and Constant Voltage outputs cannot be used simultaneously
- Total impedance Load indicated in the below diagram.

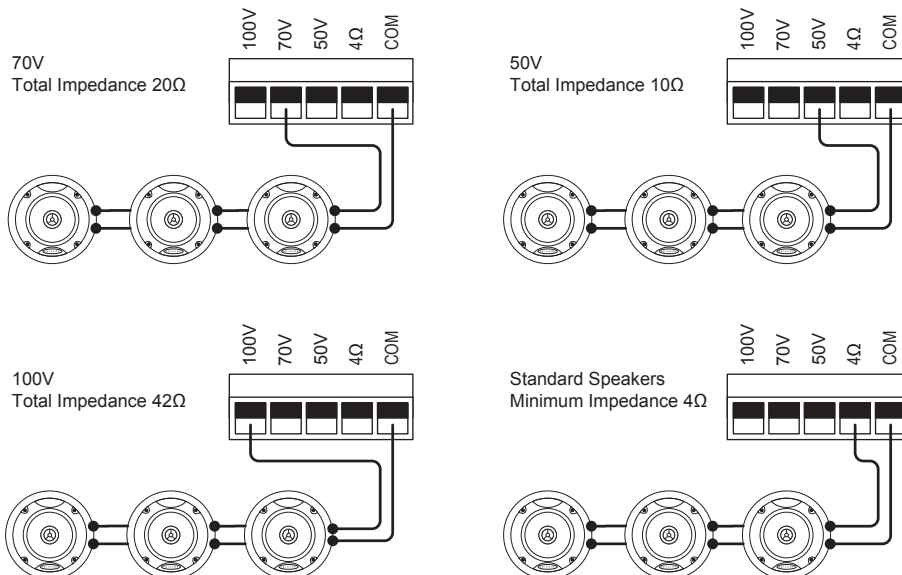

Advanced Connections

External Audio Processing

The ECA-70MIXAMP-1-240 allows for external audio processing to equalize the output to suit the installed environment. This is achieved by using the unbalanced Pre Out and Amp In connections.

Note: This connection is effected by Master Volume, Bass and Treble Controls, keep this in mind when calibrating the external processor.

1. Remove the jumper between the Pre Out and Amp In Connections
2. Connect the Pre Out to the input of the external processor
3. Connect the output of the external processor to the Amp In connection.
4. Adjust the master volume to the 12 o' clock position; this will provide an output level in the middle of the volume range.
5. Calibrate the external processor following the instructions provided with that device.

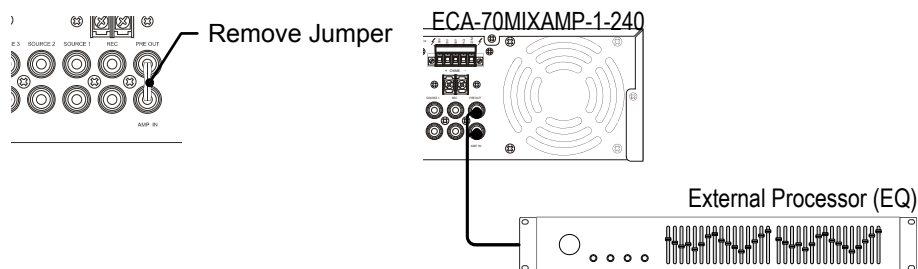

Cascading Amplifiers

Multiple ECA-70MIXAMP-1-240 can be used in a system where more audio distribution is needed. This is achieved by using the unbalanced Rec Line Out to send the signal from Amp1 to the additional amplifiers.

Note: The Rec Line Out is effected by Bass and Treble controls; adjust the tone of Amp1 first and then adjust the tone of the additional amplifiers.

1. Connect the Rec Line Out of Amp1 to a Source on Amp2.
2. Set the gain for the source used to Max, allowing for the volume from Amp1 mics/sources to be at the highest level.
3. Repeat for additional amplifiers.
4. Adjust the tone of Amp1 and then adjust the additional amps in order (Amp1, Amp2, and etc.).

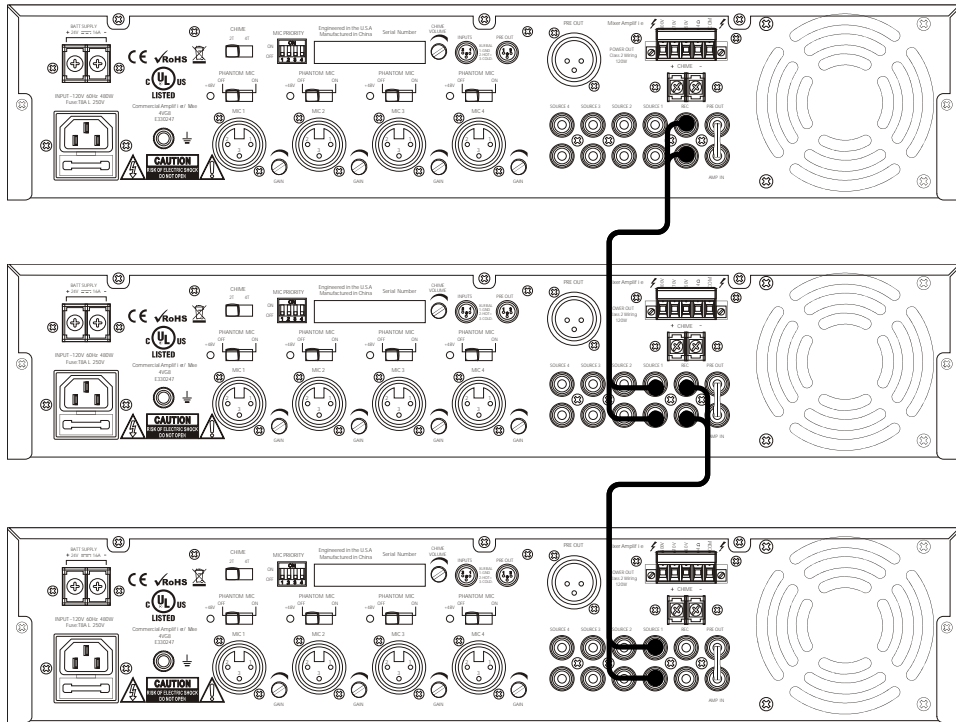

Specifications

Rated Power Output	240 watts
4 Microphone Inputs	$\pm 2.5\text{mV}/2\text{K}\Omega$ XLR balanced with phantom power
Phantom Power	+48v
Input Sensitivity/Impedance	Source 1:350mV/47k Ω
	Source 2:350mV/47k Ω
	Source 3:350mV/47k Ω
	Source 4:350mV/47k Ω
Signal To Noise Ratio	>73dB
Frequency Response	70Hz-16KHz +1,-3dB)
Control	
Bass	$\pm 10\text{dB}$
Treble	$\pm 10\text{dB}$
Chime	2 and 4 tone options
Output Sensitivity /Impedance	1000mV/470 Ω
Output Rec/Impedance	200mV/470 Ω
Distortion	<0.1%
Operating Condition	
AC Mains Input	120V AC, 24V DC(Optional)
Dimensions (D x W x H)	19x14.3x3.5
Power Consumption	480 watts
Weight	36.4 lbs

Troubleshooting

Amp will not turn on.	<ul style="list-style-type: none"> • Power cable to the amplifier is incorrectly connected or plugged into an outlet that does not have power. Check connections and verify power on the outlet. • Main Power Fuse is blown. Replace fuse and ensure power outlet is providing the correct power and polarity for the amplifier
POWER LED is red	<ul style="list-style-type: none"> • Amplifier is in Protection mode. Short circuit on input or output or too much current being drawn on speaker output. Verify all wiring and connections. • Calculate load attached to amp and configure so that impedance or wattage output is within specification. • Amplifier is overheating. Unplug amp and let cool. Install per instructions in manual, "Positioning the Amplifier".
Hum or buzzing sound is heard.	<ul style="list-style-type: none"> • Check RCA input cables by removing them one at time (powering down the amplifier before disconnecting) and checking to see if a connection or cable is to blame.
No audio from speakers.	<ul style="list-style-type: none"> • Verify speakers and wiring connections. Bypass volume controls and test output with one speaker on known good wire run. • Be sure that amp jumper is in place between "Pre-Out" and "Amp In" ports. • Verify correct source operation and input wiring. Turn volume in source up to an audible level. Turn Input or Master volume up to an audible level. • Is Power LED red? If so, see section above, "POWER LED is RED".
No sound from microphone input	<ul style="list-style-type: none"> • Set the phantom power switch to the correct mode for microphone. Verify with microphone manufacturer.

Note: If any of the troubleshooting methods listed above do not resolve the issue, please contact our Technical Support department.

Contacting Technical Support

Phone: (866) 838-5052

Email: Techsupport@snapav.com

Warranty

5-Year Limited Warranty

Episode® Amplifier Products have a 5-Year Limited Warranty. This warranty includes parts and labor repairs on all components found to be defective in material or workmanship under normal conditions of use. This warranty shall not apply to products which have been abused, modified or disassembled. Products to be repaired under this warranty must be returned to SnapAV or a designated service center with prior notification and an assigned return authorization number (RA).

