

QN800D

**Dimensions in millimeters (+ / - 0.1 mm)*

QN800D 65/75/85" SET DIMENSION

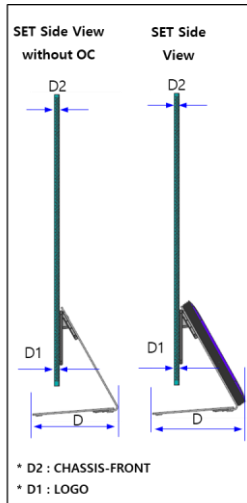

	QN800D 65"	QN800D 75"	QN800D 85"
SET(With stand) (W * H * D)	1443.7 * 898.2 * 267.9	1668.3 * 1023.8 * 286.4	1893.4 * 1153.4 * 303.7
SET(With stand & With OC) (W * H * D)	1443.7 * 898.2 * 287.1	1668.3 * 1023.8 * 310.3	1893.4 * 1153.4 * 327.8
SET(Without stand) (W * H1(H2) * D2(D1))	1443.7 * 823.2(828.4) * 17.2(19.0)	1668.3 * 950.4(955.6) * 17.64(19.0)	1893.4 * 1077.7(1083.0) * 17.64(19.0)
* Front Opening Area (A * B * C)	1442.1 * 813.3 * 1655.6	1666.7 * 939.8 * 1913.4	1891.8 * 1067.1 * 2172.0
Wall Mount (Vesa) (a * b)	400 * 300	400 * 400	600 * 400
Packing Out (W * H * D)	1625 * 947 * 210	1872 * 1124 * 191	2090 * 1260 * 220
Net Weight (With stand) Kg	32.6	43.7	57.7
Net Weight (Without stand) Kg	22.5	31.9	44.4
Gross Weight (Package) Kg	43.4	57.0	74.0

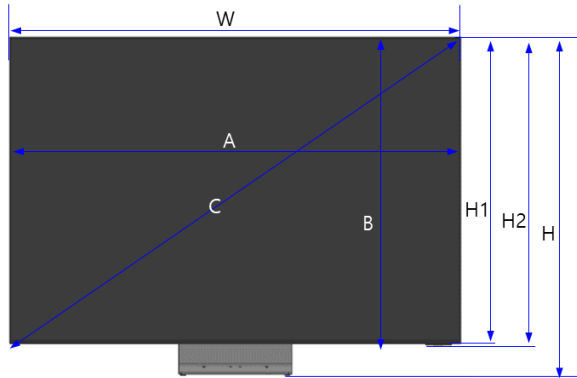

*Including Rubber
SET Front View

* H1: CHASSIS-FRONT, H2: LOGO

- ※ Height Type
- 1) H : Includes Rubber-Foot
- 2) H1 : Representative Dimension. Outermost dimension of Chassis-Front.
- 3) H2 : Includes Logo

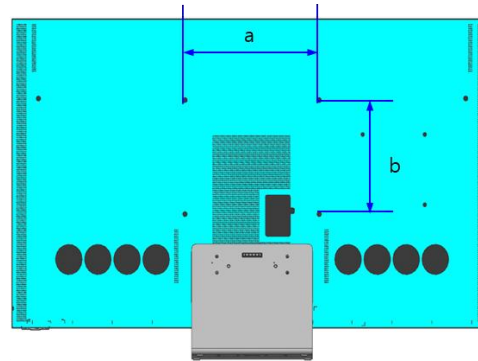

SET Rear View without OC

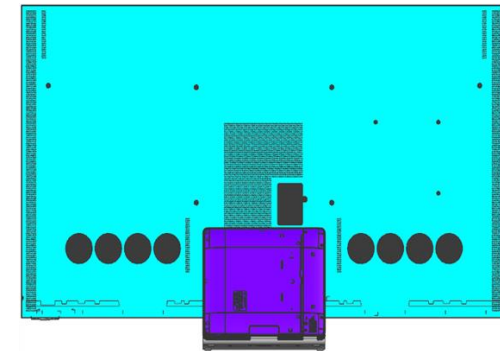

SET Rear View with OC

**Dimensions in millimeters (+ / - 0.1 mm)*

QN800D Cover and Rear-View Dimensions

		QN800D		
		65"	75"	85"
VESA WALL MOUNT(AXB)		400 X 300	400 X 400	600 X 400
C		521.9	634.2	646.7
D		219.6	216.8	216.2
E		303.6	333.6	461.5
Screw Depth		5-6	5-6	5-6
SLIM WALL MOUNT	H	215.3	216.7	216.4
	I	85.3	86.7	88.2
WALL MOUNT OC	J	310.1	380.6	481.3
	K	185.0	185.0	185.0
	L	207.4	288.2	301.7
	M	185.0	185.0	185.0

※ C,D
1) Outermost dimension of SET (Chassis-Front & C/Rear)

Detail "F"

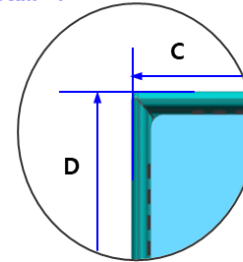

Detail "G"

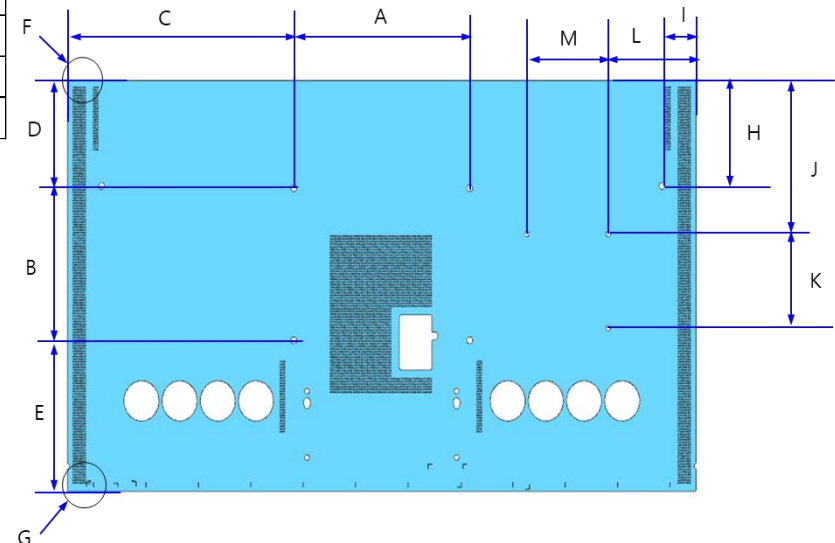
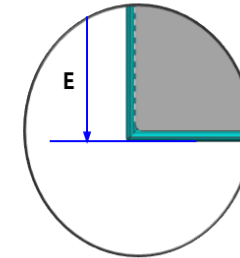

QN800D

**Dimensions in millimeters (+ / - 0.1 mm)*

QN800D 65" Cover and Rear-View Dimensions

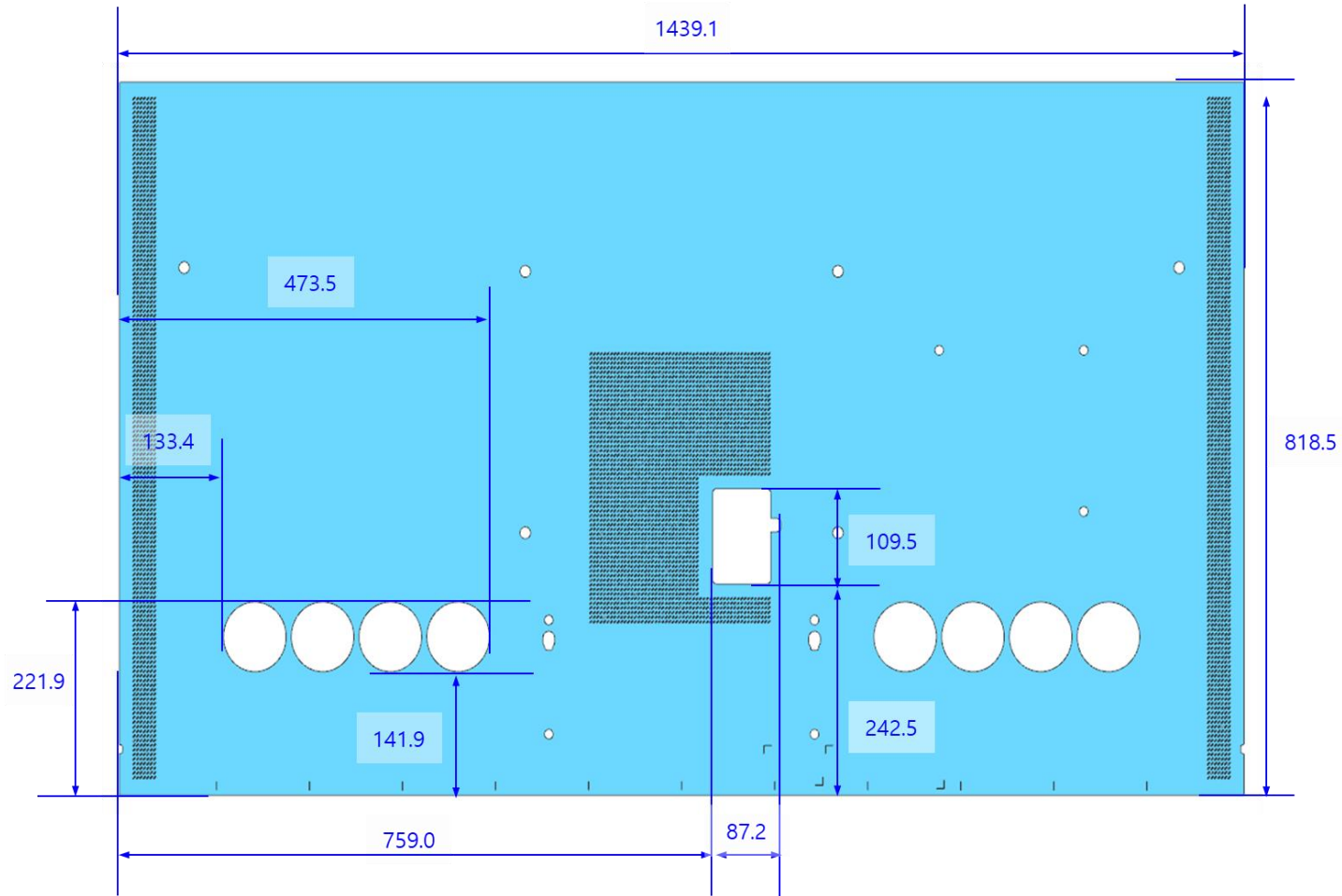

QN800D

**Dimensions in millimeters (+ / - 0.1 mm)*

QN800D 75" Cover and Rear-View Dimensions

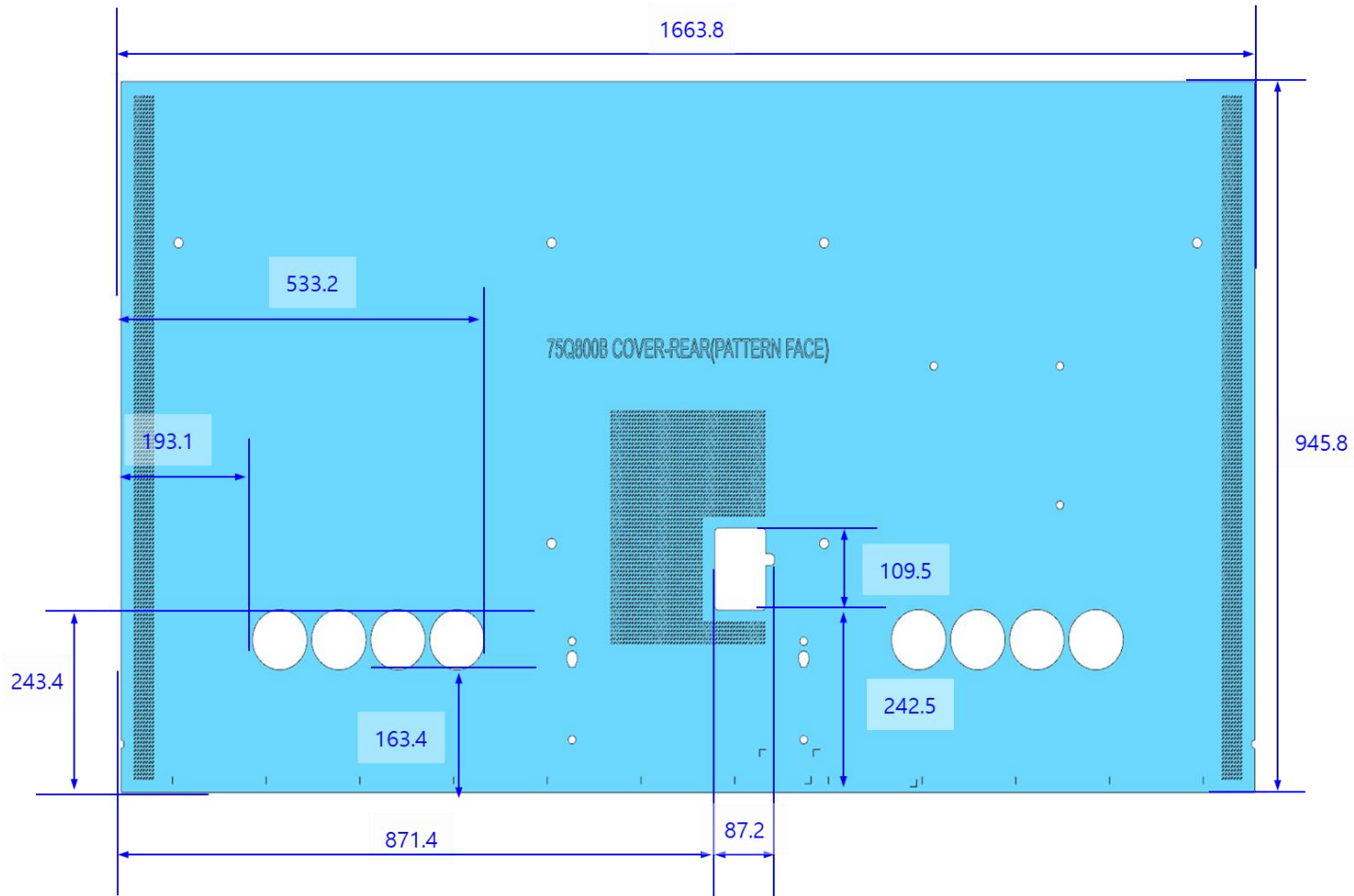

QN800D

**Dimensions in millimeters (+ / - 0.1 mm)*

QN800D 85" Cover and Rear-View Dimensions

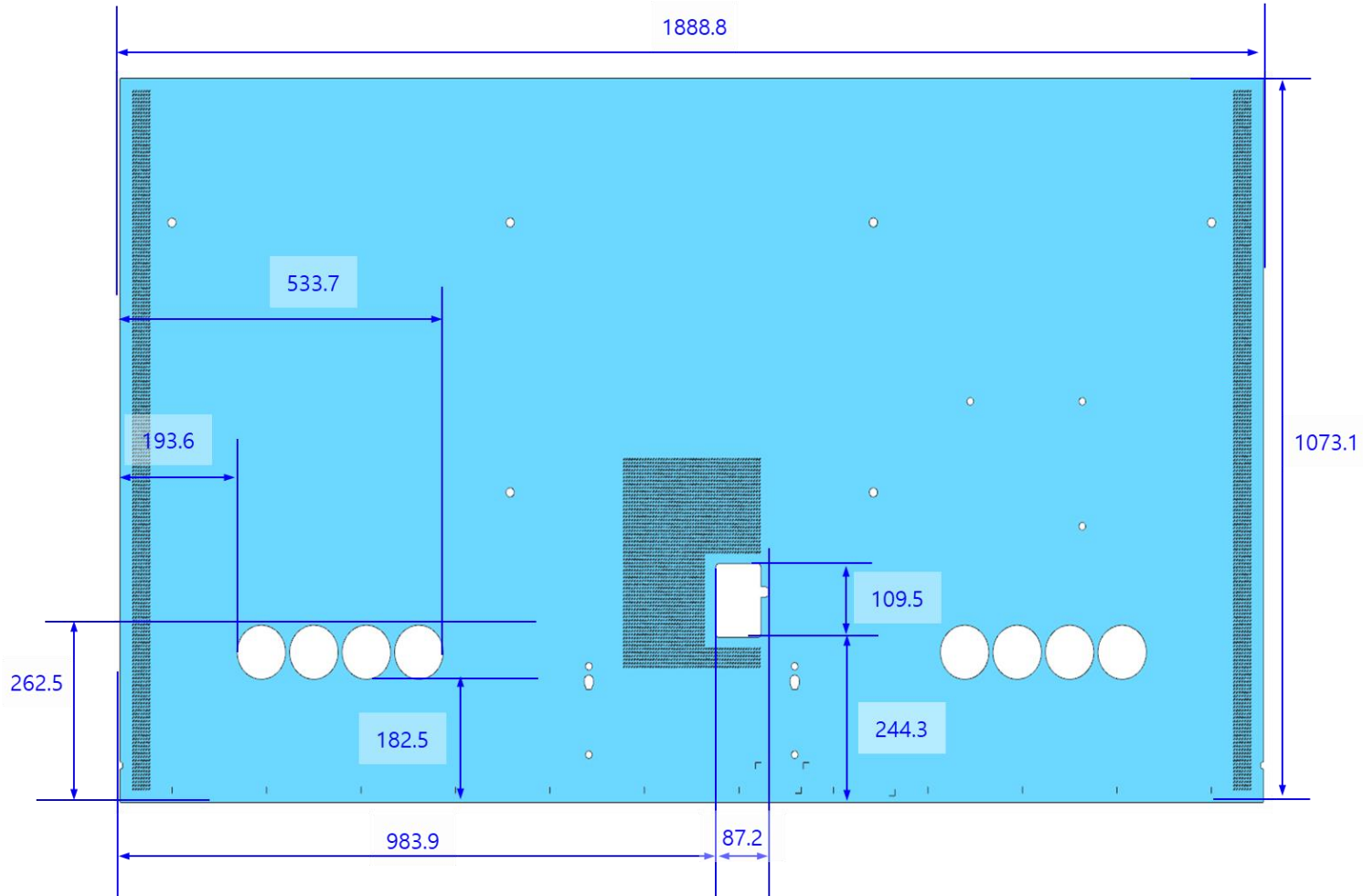

QN800D

**Dimensions in millimeters (+ / - 0.1 mm)*

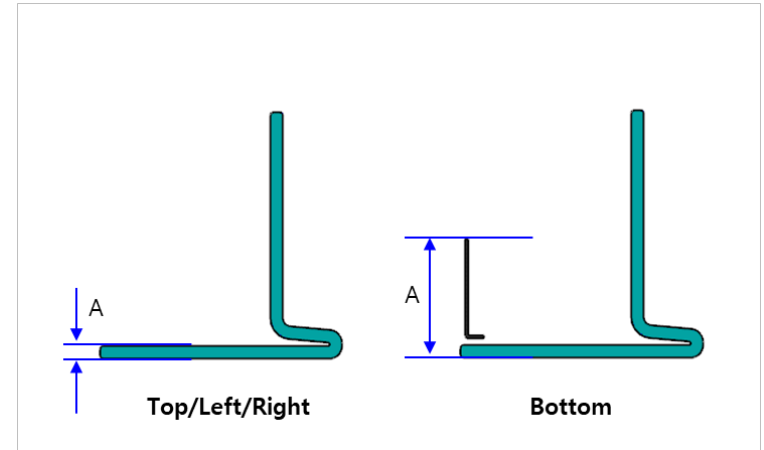
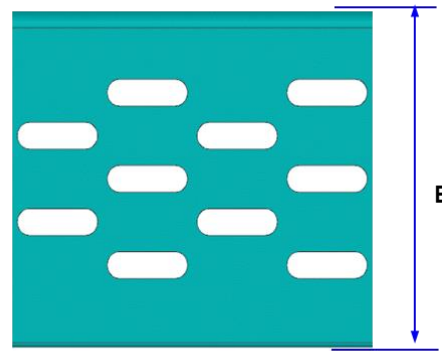
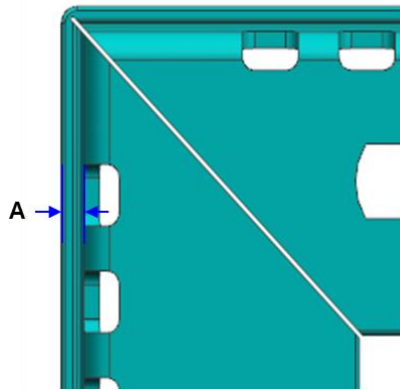

QN800D Bezel Size

	QN800D					
	65"		75"		85"	
	T/L/R	Bottom	T/L/R	Bottom	T/L/R	Bottom
A	0.8	9.1	0.8	9.8	0.8	9.8
B	17.7		17.7		17.7	

QN800D

**Dimensions in millimeters (+ / - 0.1 mm)*

QN800D Stand Dimensions

	QN800D		
	65"	75"	85"
STAND (W*H*D)	360.0*296.6*267.9	360.0*296.4*286.4	360.0*296.9*303.7

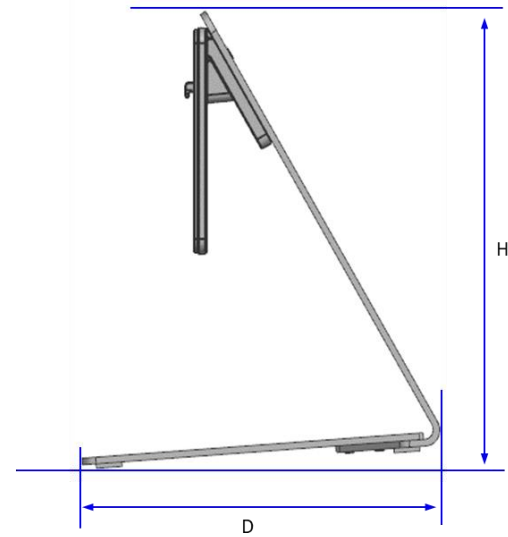
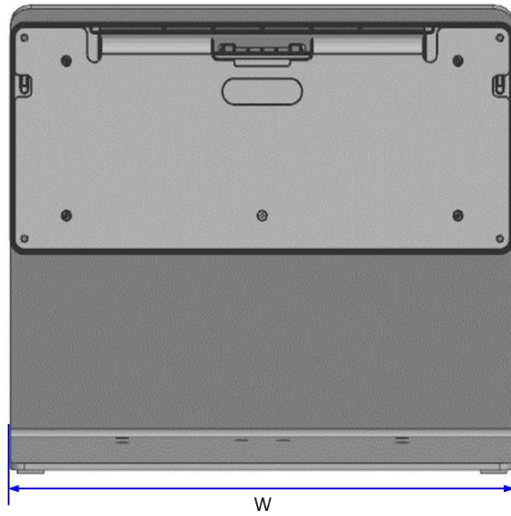
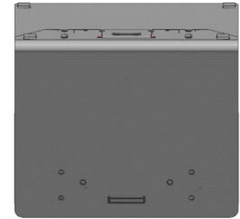

*Includes Rubber

QN800D

**Dimensions in millimeters (+ / - 0.1 mm)*

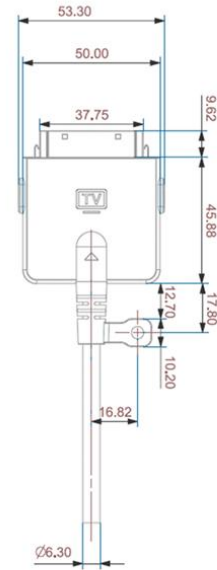
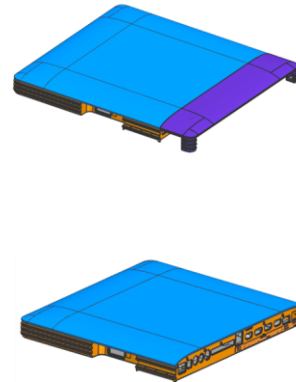
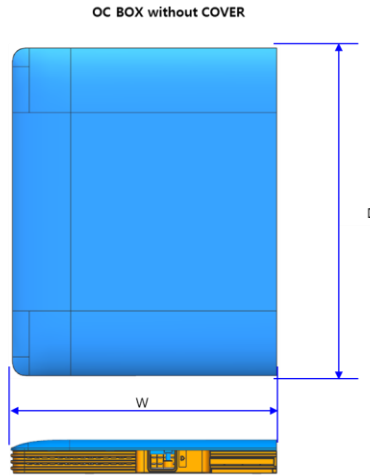
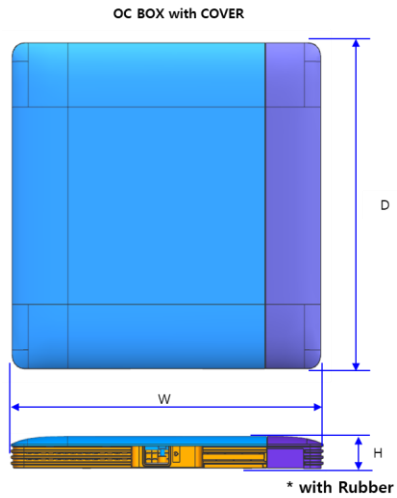

QN800D One Connect Box Size

Included OneConnect Cables
0.3M (Short)
2.5M (Long)

	QN800D
OC BOX (with COVER) (W*H*D)	360.0 * 32.9 * 330.0
OC BOX (without COVER) (W*H*D)	295.0 * 32.9 * 330.0

QN800D

**Dimensions in millimeters (+ / - 0.1 mm)*

2024 New Model IR Sensor Information

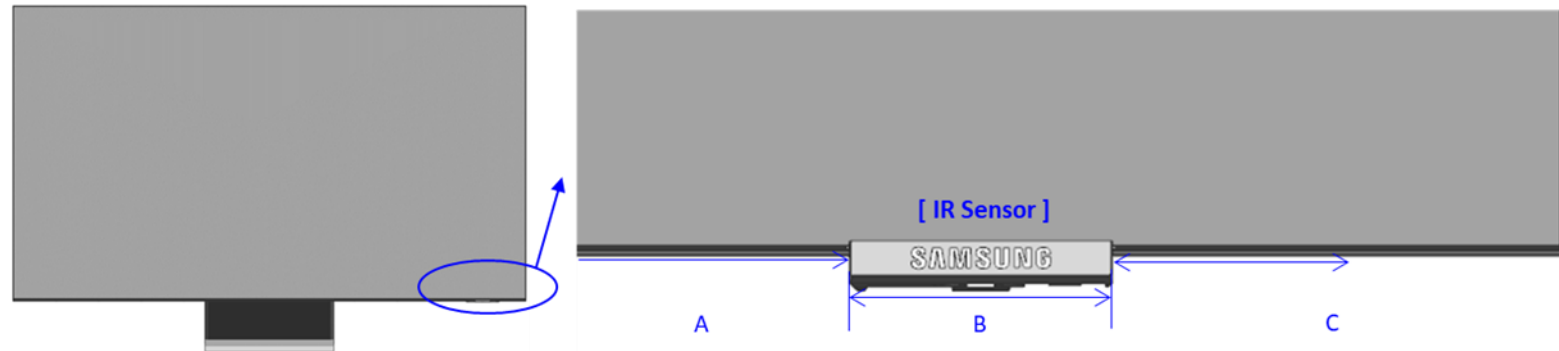

Product	Series	Inch	Item	Sensor Position	DIMENSION		
					A	B	C
	QN800D	85	QN85QN800DFXZA	Right	1783.4	24.7	85.3
		75	QN75QN800DFXZA	Right	1569.2	24.7	74.4
		65	QN65QN800DFXZA	Right	1355.3	24.7	63.7