

# QN85D

*\*Dimensions in millimeters (+ / - 0.1 mm)*

## QN85D Set Dimension

※ Height Type  
 1) H : Includes Rubber-Foot (2.0T)  
 2) H1 : Representative Dimension. Outermost dimension of Chassis-Front.  
 3) H2 : Includes Logo

	55"	65"	75"	85"
SET(With stand) (W * H * D)	1227.6*766.0*243.9	1446.5*890.0*258.8	1670.2*1015.9*274.9	1892.4 * 1141.4 * 309.3
SET(Without stand) (W * H1(H2) * D1(D2))	1227.6*704.0(706.4)*46.1(47.3)	1446.5*827.1(829.5)*46.3(47.5)	1670.2*955.9(958.2)*46.7(47.8)	1892.4*1080.5(1082.9)*47.0(48.1)
Front Opening Area (A * B * C)	1221.4 * 687.6 * 1401.6	1440.3 * 810.7 * 1652.8	1664.0*936.5*1909.4	1886.2*1061.4*2164.3
Wall Mount (Vesa) (a * b)	200*200	400*300	400*400	600*400
Packing Out (W * H * D)	1445*828*164	1633*935*180	1872*1100*186	2150*1235*209
Net Weight (With stand) Kg	20.1	26.8	38.5	49.7
Net Weight (Without stand) Kg	17.1	23.1	33.1	42.5
Gross Weight (Package) Kg	25.6	34.7	48.3	62.9

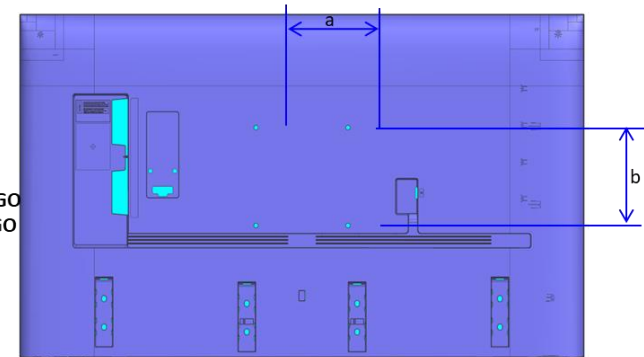
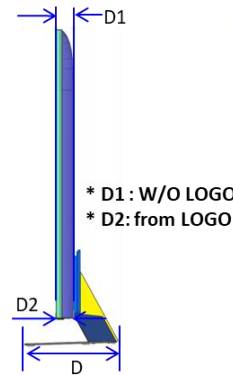
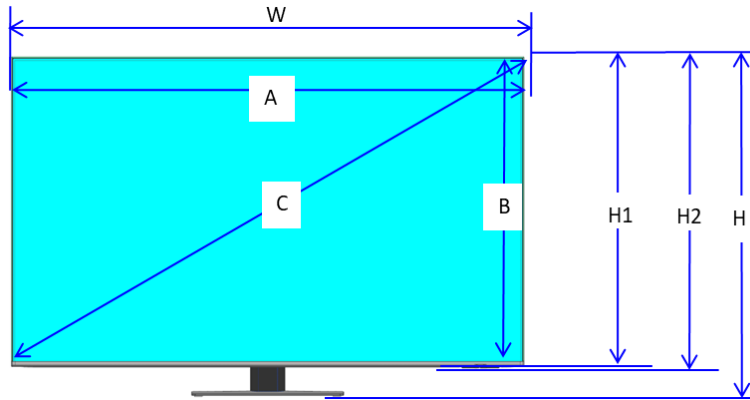

**\*Dimensions in millimeters (+ / - 0.1 mm)**

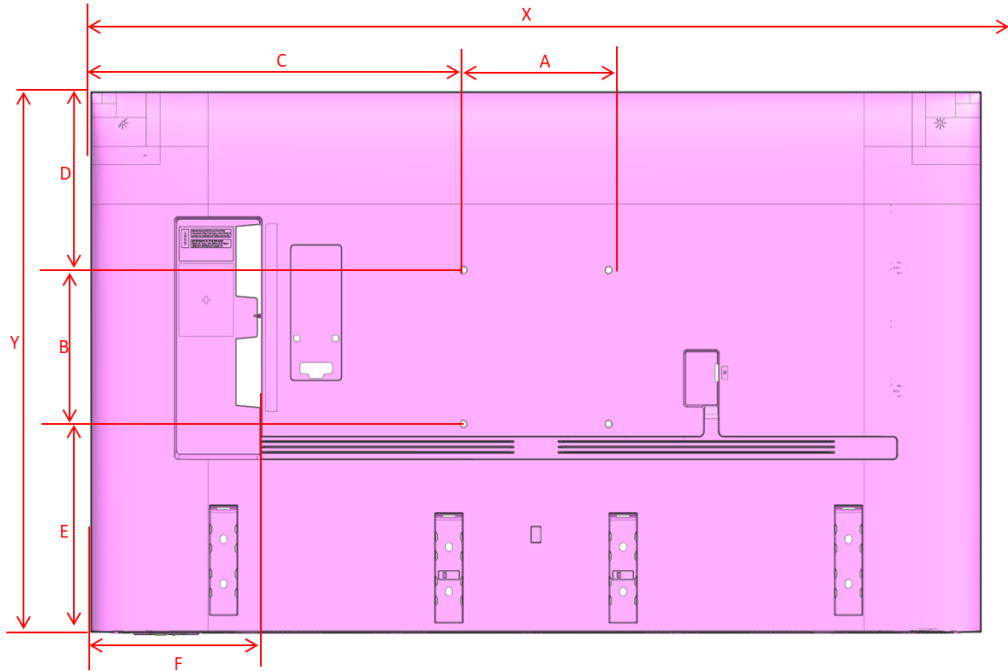

**QN85D Cover and Rear-View Dimensions**

	55"	65"	75"	85"
<b>WALL MOUNT(A*B)</b>	200*200	400*300	400*400	600*400
<b>C</b>	513.8	523.4	635.1	646.2
<b>D</b>	232.1	216.9	226.1	210.7
<b>E</b>	274.3	312.8	332.1	472.3
<b>F</b>	237.9	267.5	322.2	412.3
<b>X</b>	1227.6	1446.7	1670.2	1892.4
<b>Y</b>	706.4	829.6	958.2	1082.9
<b>Screw Depth</b>	11-13	11-13	11-13	11-13

\* E, Y : Measured including LOGO  
 F : Measured including USB Connector

# QN85D

**\*Dimensions in millimeters (+ / - 0.1 mm)**

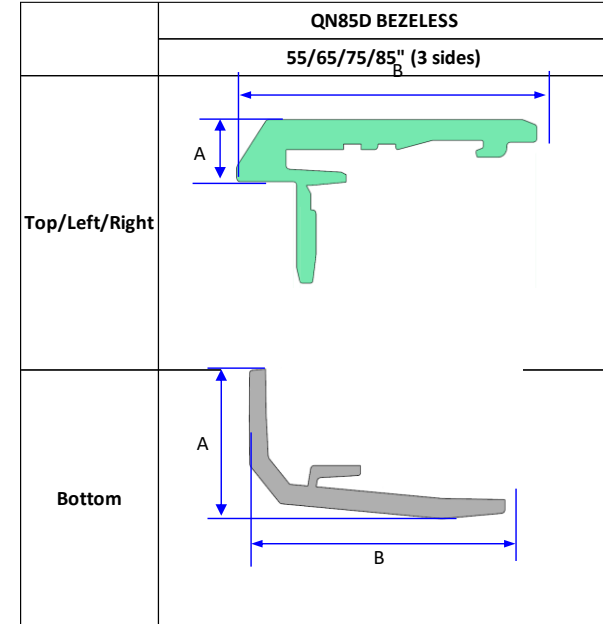
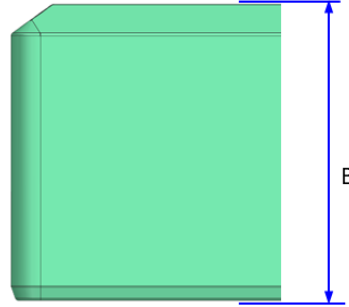
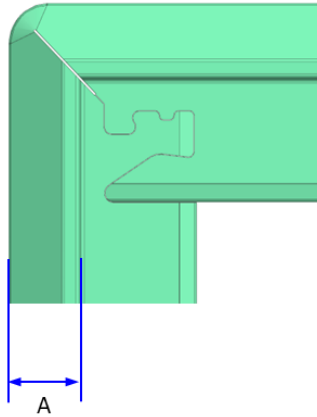

## QN85D Bezel Dimensions

	QN85D							
	55"		65"		75"		85"	
	T/L/R	Bottom	T/L/R	Bottom	T/L/R	Bottom	T/L/R	Bottom
<b>A</b>	3.1	13.3	3.1	13.3	3.1	16.3	3.1	16.0
<b>B</b>	17.0	24.2	17.0	24.2	17.4	24.2	17.80	24.9

# QN85D

*\*Dimensions in millimeters (+ / - 0.1 mm)*

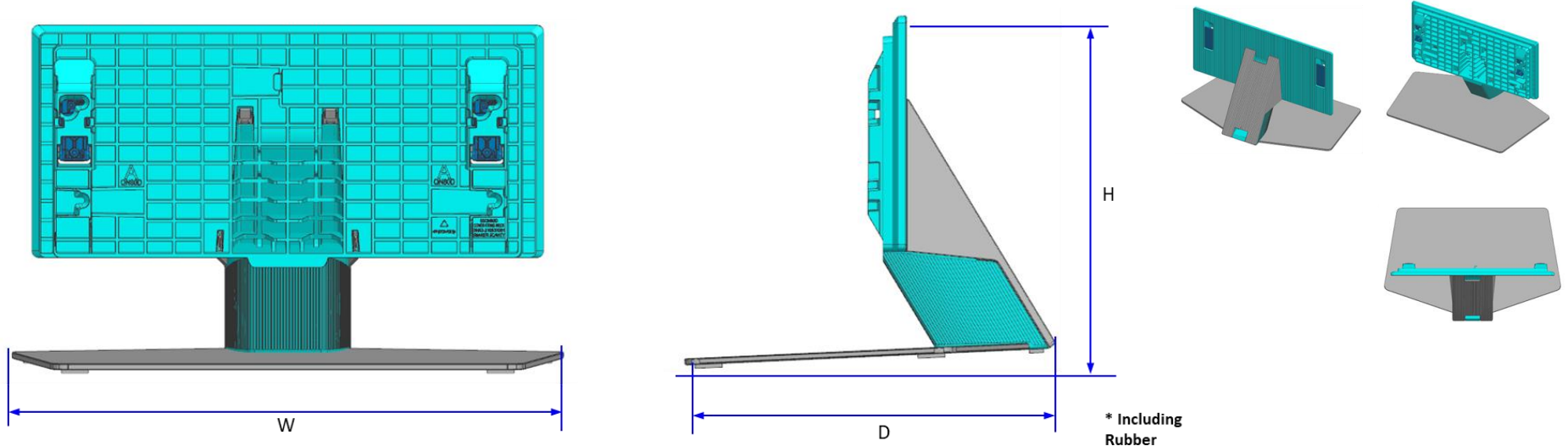

## QN85D STAND SIZE

	QN85D			
	55"	65"	75"	85"
<b>CENTER STAND (W*H*D)</b>	361.7 * 231.1 * 243.9	387.4 * 247.7 * 258.8	417.5 * 263.2 * 274.9	417.8 * 279.1 * 309.3

## 2024 New Model IR Sensor Information

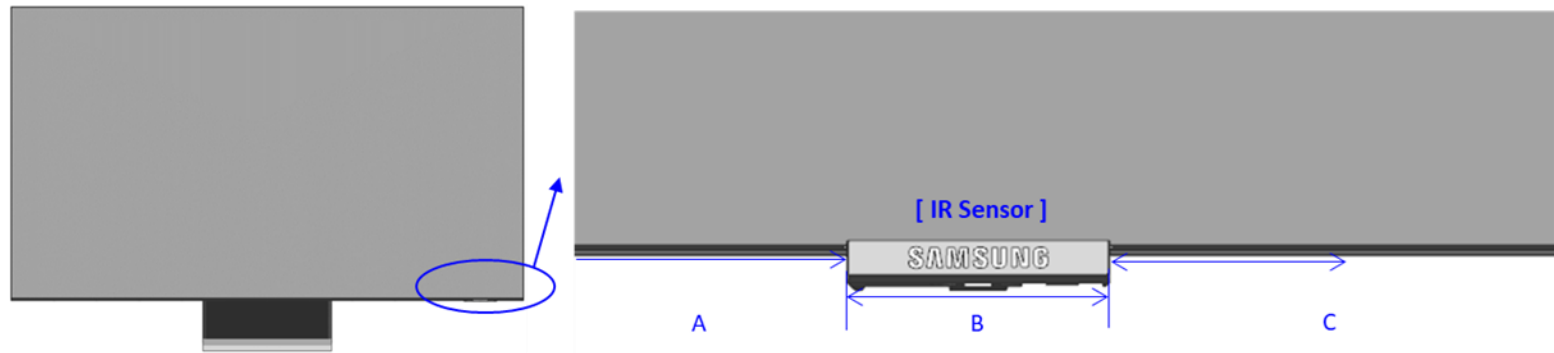

Product	Series	Inch	Item	Sensor Position	DIMENSION		
					A	B	C
	QN85D	85	QN85QN85DBFXZA	Right	1743.6	27.6	121.5
		75	QN75QN85DBFXZA	Right	1509.1	27.6	133.9
		65	QN65QN85DBFXZA	Right	1304.6	27.6	114.2
		55	QN55QN85DBFXZA	Right	1109.8	27.6	90.5