

4K HDR HDBaseT Extender with IR & RS-232,
Ethernet, Audio Return, & Loop Out
B-660-EXT-444-100AS

BINARY

INSTALLATION MANUAL



IMPORTANT SAFETY INSTRUCTIONS

To reduce the risk of fire or electric shock, read and follow all instructions and warnings in this manual. Keep this manual for future reference.

1. Do not expose this apparatus to rain or moisture. Do not expose this equipment to dripping or splashing, and ensure that no objects filled with liquids, such as vases, are placed on the equipment. Do not use this apparatus near water.
2. Do not remove cover. No user serviceable parts inside.
3. Clean only with a dry cloth.
4. Do not block any ventilation openings. Install according to manufacturer's instructions.
5. Do not install near any heat sources such as radiators, heat registers, stoves or other apparatus (including amplifiers) that produce heat.
6. Do not override the safety purpose of the polarized or grounding plug. A polarized plug has two blades, one of which is wider than the other. A grounding plug has two matching blades and a third grounding prong. The wide blade or the third prong is provided for your safety. If the provided plug does not fit into your outlet, consult an electrician for replacement of the obsolete outlet.
7. Protect the power cord from being walked on or pinched, particularly at the plug end and where the power cord is attached to the apparatus.
8. Only use attachments and accessories specified by the manufacturer.
9. Refer all servicing to qualified service personnel. Servicing is required when the apparatus has been damaged in any way, such as when the power supply cord or plug is damaged, liquid has been spilled on or objects have fallen into the apparatus, the apparatus has been exposed to rain or moisture, the apparatus does not operate normally, or it has been dropped.
10. To completely disconnect this equipment from power, disconnect the power supply cord from the power outlet.



The lightning flash with arrowhead symbol, within an equilateral triangle, is intended to alert the user to the presence of uninsulated dangerous voltage within the product's enclosure that may be of sufficient magnitude to constitute a risk of electric shock to persons.



The exclamation point within an equilateral triangle is intended to alert the user to the presence of important operating and maintenance (servicing) instructions in the literature accompanying the appliance.



FCC WARNINGS

This equipment has been tested and found to comply with the limits for a Class B digital device, pursuant to Part 15 of the FCC Rules. These limits are designed to provide reasonable protection against harmful interference in a residential installation. This equipment generates uses and can radiate radio frequency energy and, if not installed and used in accordance with the instructions, may cause harmful interference to radio communications. However, there is no guarantee that interference will not occur in a particular installation. If this equipment does cause harmful interference to radio or television reception, which can be determined by turning the equipment off and on, the user is encouraged to try to correct the interference by one or more of the following measures:

- Reorient or relocate the receiving antenna.
- Increase the separation between the equipment and receiver.
- Connect the equipment into an outlet on a circuit different from that to which the receiver is connected.
- Consult the dealer or an experienced radio/TV technician for help.

Changes or modifications not expressly approved by the party responsible for compliance could void the user's authority to operate the equipment.

TRADEMARKS

Dolby Digital™, Dolby TrueHD™, and Dolby Atmos™ are registered trademarks of Dolby Laboratories DTS 5.1™, DTS-HD Master Audio™ and DTS:X™ are registered trademarks of DTS, Inc. All other trademarks and registered trademarks are owned by their respective holders.

CONTENTS

1. Product Overview	5
2. Features.....	5
3. Package Contents.....	5
4. Device Layout.....	6
4.1. B-660-EXT-444-100AS Transmitter	6
4.2. B-660-EXT-444-100AS Receiver	8
5. Installation & Wiring	10
5.1. Installation.....	10
5.2. Wiring	10
6. EDID Management	12
7. Function Setting.....	12
7.1. Audio Setting (Group 1).....	13
7.2. IR & RS-232 Setting (Group 2).....	15
8. Connections.....	15
8.1. HDBaseT Link (RJ45) Connection.....	15
8.2. RS-232 Control Connections	16
8.2.1. RS-232 Control (DB-9) Connection.....	17
9. Specifications	18
9.1. Transmission Distance	19
10. Warranty.....	19
11. Support	19

1. PRODUCT OVERVIEW

The B-660-EXT-444-100AS is a 4K HDR HDBaseT extender with HDMI loop out and support for 4K@60Hz 4:4:4 8bit including DCI 4K (4096 x 2160), and HDCP 2.2 compatibility. It can transmit 1080P signals up to 100m/330ft and 4K@60Hz signals up to 70m/230ft via Cat 5e/6 cable, and transmit 1080P and 4K@60Hz 4:4:4 8bit signals up to 100m/330ft via Cat 6a/7 cable.

The B-660-EXT-444-100AS supports bi-directional IR pass through, RS-232 pass through, CEC pass through, S/PDIF pass through and ethernet pass-through. It also supports ARC function, which can be configured by the Function DIP switch. With bi-directional PoC support, only one power adapter is needed. The built-in scaler, is capable of scaling down the incoming 4k (including 3840x2160 and 4096x2160) video signal automatically to 1080P when the connected display is not able to reproduce the 4k signal.

Two independent 4-pin Video and Audio EDID DIP Switches provide a variety of EDID combinations to fit the needs of the installation and operation environment. The 6-pin Function DIP Switches provide a variety of configurations and upgrading requirements to fit multiple application scenarios.

2. FEATURES

- Supports resolutions up to 4K@60Hz 4:4:4 8bit and HDCP 2.2.
- Supports HDR (High Dynamic Range), including HDR 10, HLG up to 4K@60 and HDR 10+ and Dolby Vision up to 4K@30Hz.
- The transmitter supports local output/loop out.
- Supports digital and analog audio de-embedding and S/PDIF pass through.
- Over a Cat 5e/6 cable, HDBT transmits 4K@60Hz 4:4:4 8bit up to 70m/230ft, and 1080P up to 100m/330ft; Over a Cat 6a/7 cable, HDBT transmits 4K@60Hz 4:4:4 8bit and 1080P up to 100m/330ft.
- DIP Switches configure EDID, IR, RS-232, ARC functions and FW update.
- Ability to down-scale automatically.
- CEC pass through capable.
- Supports bi-directional IR pass through, RS-232 pass through and ethernet pass through.
- Bi-directional PoC, one power adapter at either transmitter or receiver side can power both units.

3. PACKAGE CONTENTS

- 1 x B-660-EXT-444-100AS Extender
- 1 x DC 12V Power Adapter with US Pins
- 4 x Mounting Ears (with Screws)
- 4 x Drywall Screws
- 8 x Rubber Feet
- 1 x Installation Manual

4. DEVICE LAYOUT

4.1. B-660-EXT-444-100AS Transmitter



1. POWER LED

On/Off: The transmitter is powered on/off.

2. STATUS LED

Blinking: The transmitter is working properly.

Off: The transmitter is not working properly.

3. LINK LED

On: HDBT link is normal.

Off: No HDBT link.

4. HDCP LED

On: HDCP encrypted signal is being transmitted.

Blinking: Non-HDCP encrypted signal is being transmitted.

Off: No signal is being transmitted.

5. SCALER LED

On: The Scaler function is enabled.

Off: The Scaler function is disabled.

6. Video

Video EDID DIP Switch. For more information, see EDID Management Section.

7. Audio

Audio EDID DIP Switch. For more information, see EDID Management Section.

8. Function

Function DIP Switch. For more information, see Function Setting Section.

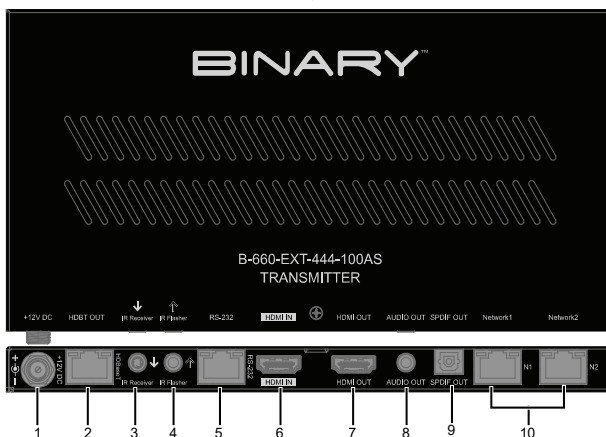

1. +12V DC

Connect the 12V power cord provided.

2. HDBT OUT

Connect to the receiver via a Cat 5e/6/6a/7 cable.

3. IR Receiver

Connect to an IR receiver cable.

4. IR Flasher

Connect to an IR emitter cable.

5. RS-232

RJ45 port. Connect to a RS-232 control device such as a control system for RS-232 pass-through or a PC for firmware update.

6. HDMI IN

Connect to an HDMI source device.

7. HDMI OUT

Connect to an HDMI display device.

8. AUDIO OUT

3.5mm analog audio out, HDMI IN de-embedding, connect to an audio system.

9. SPDIF OUT

TOSLINK connector, connect to an audio system such as an AV receiver.

10. Network 1&2

Connect to internet devices or to the internet. These two ports share the same built-in switch, so when one of the network ports is connected to an Ethernet switch, the other port is prohibited to connect to the same switch to avoid network loops.

4.2. B-660-EXT-444-100AS Receiver



1. POWER LED

On/Off: The receiver is powered on/off.

2. STATUS LED

Blinking: The receiver is working properly.

Off: The receiver is not working properly.

3. LINK LED

On: HDBT link is normal.

Off: No HDBT link.

4. HDCP LED

On: HDCP encrypted signal is being transmitted.

Blinking: Non-HDCP encrypted signal is being transmitted.

Off: No signal is being transmitted.

5. ARC LED

On: ARC function is enabled.

Off: ARC function is disabled.

6. Function

Function DIP Switch. For more information, see Function Setting Section.

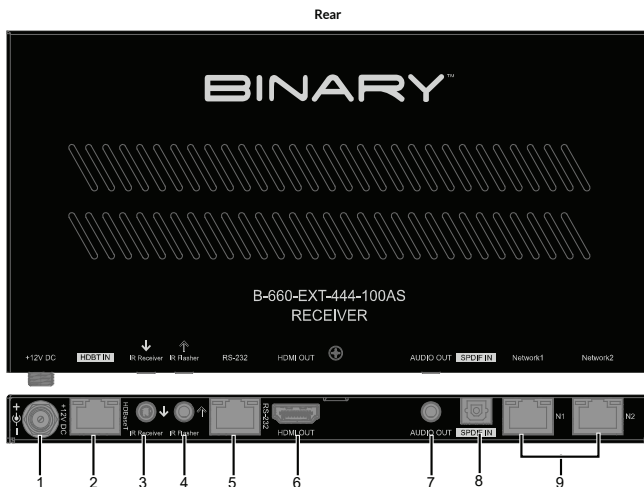

1. +12V DC

Connect the 12V power cord provided.

2. HDBT IN

Connect to the transmitter via a Cat 5e/6/6a/7 cable.

3. IR Receiver

Connect to an IR receiver cable.

4. IR Flasher

Connect to an IR emitter cable.

5. RS-232

RJ45 port. Connect to a RS-232 control device such as a control system for RS-232 pass-through or a PC for firmware update.

6. HDMI OUT

Connect to an HDMI display.

7. AUDIO OUT

3.5mm analog jack, HDMI OUT audio de-embedding, connect to an audio system such as an amplifier.

8. SPDIF IN

TOSLINK connector, connect to an audio source device.

9. Network 1&2

Connect to internet devices or to the internet. These two ports share the same built-in switch, so when one of the network ports is connected to an Ethernet switch, the other port is prohibited to connect to the same switch to avoid network loops.

5. INSTALLATION & WIRING

5.1. Installation

Before installation, please ensure the device is disconnected from the power.

Steps to install the device on a suitable position:

1. Attach the mounting ear to the enclosure using the screws provided in the package separately.
2. The mounting ear is attached to the enclosure as shown.

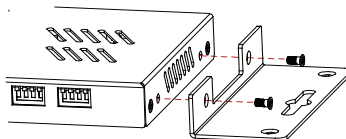

3. Repeat steps 1-2 for the other side of the transmitter.
4. Repeat above steps to install the receiver.

5.2. Wiring

Warnings:

- Before wiring, disconnect the power from all devices.
- During wiring, connect and disconnect the cables gently.

Steps for device wiring:

1. Connect HDMI IN

Connect the HDMI sources (such as PC, Blu-ray player, Apple TV, 4K media player, etc.) to the HDMI IN of the transmitter.

2. Connect HDBT OUT

Connect HDBT OUT of the transmitter to HDBT IN of the receiver with Cat 5e/6/7 cables.

3. Connect HDMI OUT

Connect HDMI display device (such as TV, projector) to the HDMI OUT of the transmitter and receiver.

4. Connect Audio Outputs

Set the front panel Function1 DIP switch to down or "audio de-embedding" mode, and connect to the SPDIF OUT or AUDIO OUT port.

5. Connect for additional control options:

- **IR Pass Through:** Connect the IR emitter cable to the IR Flasher port or the IR receiver cable to the IR Receiver port of the transmitter, and connect the IR receiver cable to the IR Receiver port or the IR emitter cable to the IR Flasher port of the receiver. The source remote can control the source at the receiver side or the display remote can control the display at the transmitter side.
- To set RS-232 mode see "Function Setting" Section, below. Connect the RS-232 ports of a control system to the RS-232 ports of the transmitter and receiver to facilitate RS-232 pass through. For details, see, RS-232 Control Connections Section.
- **ETHERNET Pass Through:** A built in Ethernet switch is provided on the Transmitter and Receiver in order to pass through internet connectivity via the HDBaseT connection to local devices at the end point.

6. Connect the DC 12V power cord provided.

7. Power on all attached devices.

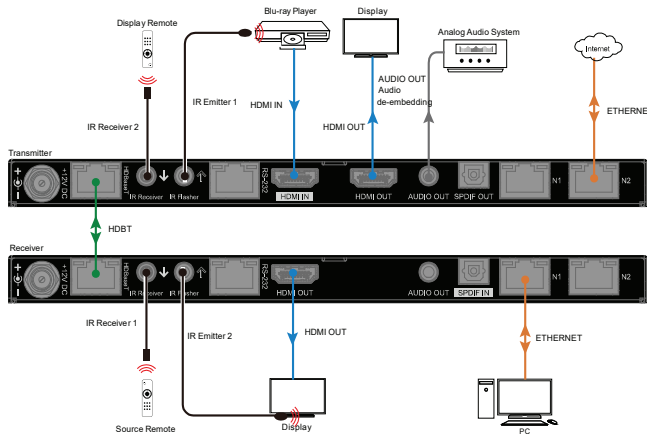

Application Diagram 1

To connect HDMI de-embedding audio for amplification, when using 3.5mm AUDIO OUT, the transmitter front panel AUDIO dip switch should be set to 2CH PCM.

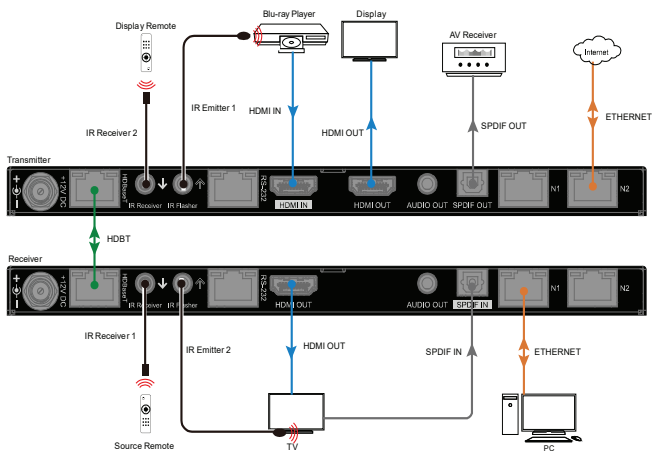

Application Diagram 2

To connect HDMI de-embedding audio for amplification, and when using SPDIF OUT port, the transmitter front panel AUDIO dip switch should be set to COMPRESSED 5.1. At same time, the 3.5mm AUDIO OUT port will be muted.

When using SPDIF OUT for audio return from the receiver SPDIF IN, the transmitter Function 1 dip switch should be set to UP.

6. EDID MANAGEMENT

EDID is configured by separate Video and Audio DIP Switches. The default setting is Auto., please refer to the following table to configure

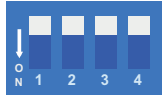

Video		DIP Switch Position			
EDID	Resolution	1	2	3	4
0	Auto (Default)	Up	Up	Up	Up
1	1080P SDR	Up	Up	Up	Down
2	1080P HDR	Up	Up	Down	Up
3	4K@30 SDR	Up	Up	Down	Down
4	4K@30 HDR	Up	Down	Up	Up
5	4K@60 4:2:0 SDR	Up	Down	Up	Down
6	4K@60 HDR	Up	Down	Down	Down
7	EDID Copy (HDBaseT OUT)	Down	Down	Down	Down

Audio		DIP Switch Position			
EDID	Resolution	1	2	3	4
0	Auto (Default)	Up	Up	Up	Up
1	2CH (PCM)	Up	Up	Up	Down
2	6CH (PCM)	Up	Up	Down	Up
3	Compressed 5.1	Up	Up	Down	Down
4	8CH (PCM)	Up	Down	Up	Up
5	Compressed 7.1	Up	Down	Up	Down
6	EDID Copy (HDBaseT OUT)	Down	Down	Down	Down

7. FUNCTION SETTING

IR, RS-232 and ARC functions can be configured by Function DIP Switch. The default setting is "Up, Up, Up, Up, Up, Up". Please refer to the following table to configure.

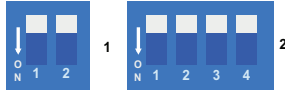

TX Function Settings Function Group 1		
Audio Settings	2-Pin DIP Positions	
	1	2
SPDIF OUT (SPDIF IN RX)	Up	-
SPDIF OUT (HDMI De-embed)	Down	-
Reserved	-	Up
Reserved	-	Down

TX Function Settings Function Group 2				
IR/RS-232/ FW Update	4-Pin DIP Positions			
	1	2	3	4
IR RCVR PWR OFF (12v)	Up	-	-	-
IR RCVR PWR ON (12v)	Down	-	-	-
DTE (RS-232)	-	Up	-	-
DCE (RS-232)	-	Down	-	-
RS-232 pass-thru	-	-	Up	Up
System f/w update	-	-	Down	Up
HDBT f/w update	-	-	Up	Down
Reserved	-	-	Down	Down

RX Function Settings Function Group 1		
Audio Settings	2-Pin DIP Positions	
	1	2
ARC (HDMI OUT)	Up	-
Audio Return (SPDIF IN)	Down	-
Reserved	-	Up
Reserved	-	Down

RX Function Settings Function Group 2				
IR/RS-232/ FW Update	4-Pin DIP Positions			
	1	2	3	4
IR RCVR PWR OFF (12v)	Up	-	-	-
IR RCVR PWR ON (12v)	Down	-	-	-
DTE (RS-232)	-	Up	-	-
DCE (RS-232)	-	Down	-	-
RS-232 pass-thru	-	-	Up	Up
System f/w update	-	-	Down	Up
HDBT f/w update	-	-	Up	Down
Reserved	-	-	Down	Down

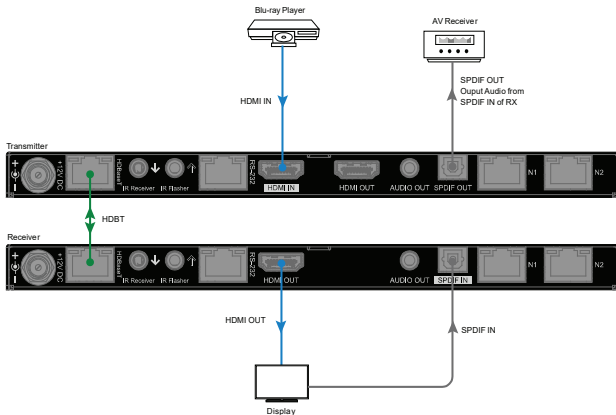

Figure 2: To return SPDIF inserted audio

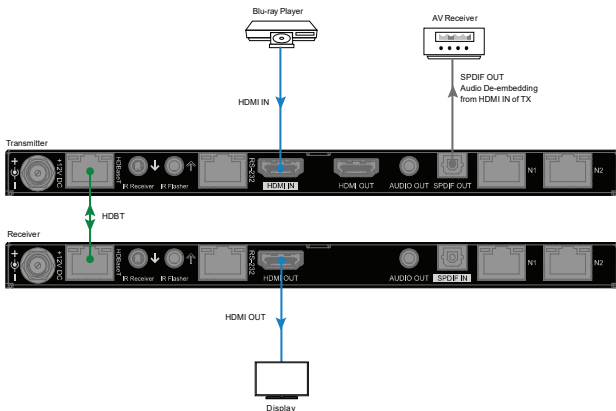

Figure 3: To extract TX HDMI IN audio

7.2. IR & RS-232 Setting (Group 2)

4-Pin (Group 2) DIP Switch of FUNCTION DIP Switch is used to set IR and RS-232 function.

- Pin1 is set to "Up", IR Receiver port does not supply 12V power, when set to "Down", IR Receiver port does supply 12V power . Transmitter and receiver are configured separately.
- Pin2 is set to "Up", RS-232 Serial DTE mode. Pin2 is set to "Down", RS-232 Serial DCE mode. Transmitter and receiver are configured separately.
- Pin3 and Pin4 are set to "Up" simultaneously, RS-232 port is set to pass through.
- Pin3 and Pin4 are set to "down, up", connect to a PC to upgrade unit firmware.
- Pin3 and Pin4 are set to "Up, Down", use Valens tool to upgrade Valens chip.

8. CONNECTIONS

8.1. HDBaseT Link (RJ45) Connection

This device is designed to operate with category cables for communication between the transmitter and receiver. The transmission path may include a maximum of two keystones and two patch cables, as long as the total length does not exceed 100 m depending on the category cable and resolution desired.

TIA/EIA Standard 568-B (Gold Pins Facing Up)

Pin 1 - White/Orange	Pin 5 - White/Blue
Pin 2 - Orange	Pin 6 - Green
Pin 3 - White/Green	Pin 7 - White/Brown
Pin 4 - Blue	Pin 8 - Brown



Figure 4: HDBaseT RJ45 Connections

Note: The HDBaseT Link RJ45 connection includes a 48V signal. Do not connect anything to this port other than a B-660-EXT-444-100AS transmitter or receiver.

8.2. RS-232 Control Connections

- Bidirectional RS-232 signals are transmitted between the device transmitter and receiver over the category cable. The transmitter may be connected to a control system, and the receiver may be connected to an RS-232 controllable device.

(A) RS-232 Control (DB-9) - See Section 8.2.1

(B) HDBaseT Link Category - See Section 8.1

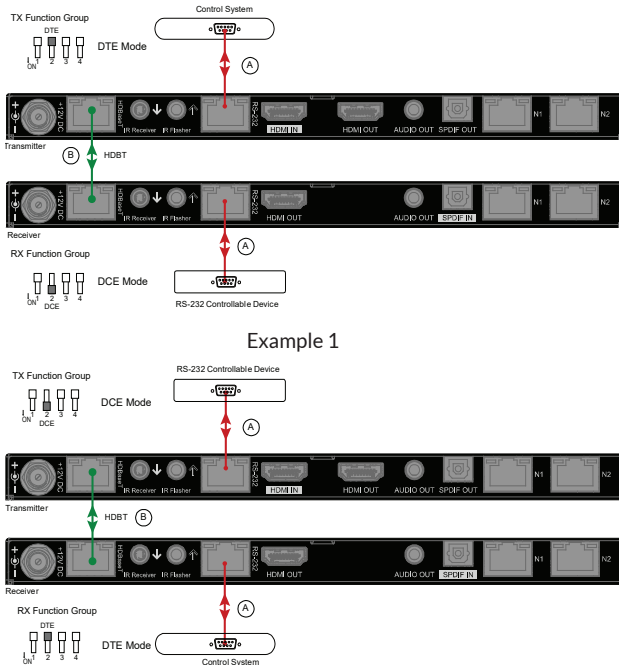

Example 2

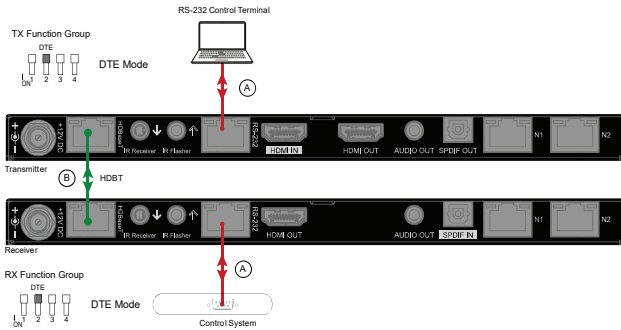

Example 3

Figure 5: RS-232 Connections

8.2.1. RS-232 Control (DB-9) Connection

To eliminate the need to make crossover or null modem cables, the RS-232 pinouts can be configured for DCE or DTE. Set switch 2 to DCE if the connected device is DCE, and to DTE if the connected device is DTE.

Typically, the control system will be DTE and the controlled device will be DCE, however, devices may vary. Refer to the manual for the connected devices for proper pinout configuration.

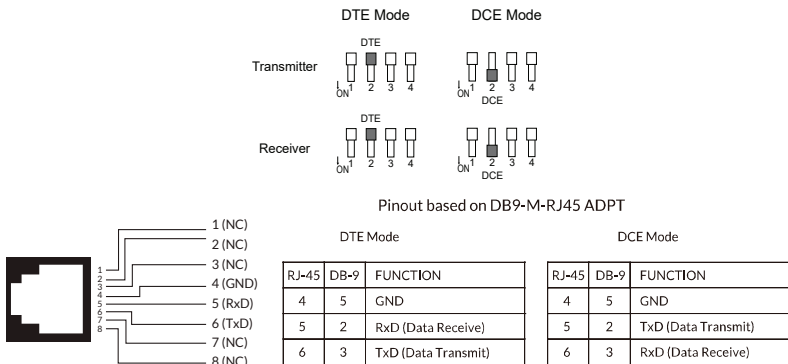

Figure 6: RS-232 Modes and Connections

9. SPECIFICATIONS

Technical	
Input/Output Port	<p>Transmitter: 1 x HDMI IN, 1 x HDBT OUT, 1 x HDMI OUT, 1 x IR Receiver, 1 x IR Flasher, 1 x RS-232 (RJ45), 1 x AUDIO OUT (3.5mm analog audio out), 1 x SPDIF OUT, 2 x ETHERNET, 1 x DC 12V IN</p> <p>Receiver: 1 x HDMI OUT, 1 x HDBT IN, 1 x IR Receiver, 1 x IR Flasher, 1 x RS-232 (RJ45), 1 x AUDIO OUT, 1 x SPDIF IN, 2 x ETHERNET, 1 x DC 12V IN</p>
Input/Output Signal Type	HDMI with 4K@60Hz YUV 4:4:4, HDCP 2.2, including DCI 4K (4090x2160)
Input/Output Resolution Supported	<p>VESA: 800x600⁸, 1024x768⁸, 1280x768⁸, 1280x800⁸, 1280x960⁸, 1280x1024⁸, 1360x768⁸, 1366x768⁸, 1440x900⁸, 1600x900⁸, 1600x1200⁸, 1680x1050⁸, 1920x1200⁸, 2560x1440⁸, 2560x1600⁸</p> <p>SMPT E: 1280x720P^{6,7,8}, 1080I^{6,7,8}, 1920x1080P^{1,2,3,4,5,6,7,8}, 3840x2160P^{2,3,5,6,8}, 4096x2160P^{2,3,5,6,8}</p> <p>NOTE: ¹ = at 23.98 Hz, ² = at 24 Hz, ³ = at 25 Hz, ⁴ = at 29.97 Hz, ⁵ = at 30 Hz, ⁶ = at 50 Hz, ⁷ = at 59.94 Hz, ⁸ = 60 Hz, ⁹ = 75 Hz</p>
Audio Format	<p>HDMI IN/OUT: Fully supports audio formats in HDMI 2.0 specification, including PCM 2.0/5.1/7.1, Dolby TrueHD™, Dolby Atmos™, DTS-HD Master Audio™ and DTS:X™</p> <p>3.5mm Analog AUDIO OUT: PCM 2.0</p> <p>SPDIF: PCM 2.0, Dolby Digital™, DTS 5.1™</p>
Maximum Data Rate	HDMI IN & HDMI OUT: 18Gbps
Control Method	IR, RS-232, CEC, DIP Switches
General	
Operating Temperature	0°C to 40°C (32°F to 104°F)
Storage Temperature	-20°C to 60°C (-4°F to 140°F)
Humidity	10% to 90%, non-condensing
ESD Protection	Human-body Model: ±15kV (Air-gap discharge)
Power Supply	DC 12V 3A
Power Consumption (Max)	<p>Receiver is powered by transmitter: 28.44W</p> <p>Transmitter is powered by receiver: 28.92W</p> <p>Transmitter and receiver are powered separately: Transmitter: 10.44W, Receiver: 12.12W</p>
Device Dimension (W x H x D)	212.5mm x 15.4mm x 110mm/8.37" x 0.61" x 4.33" (Transmitter/Receiver, without mounting ears)
Product Weight	0.48kg/1.05lb

9.1. Transmission Distance

Note: Straight-through category cable wired to T568B standard is recommended.

Cable Type	Range	Supported Video
Cat 5e/6	100m/330ft	Up to 1080P@60Hz 36bpp
	70m/230ft	1080P@60Hz 48bpp 4K@30Hz 24bpp
Cat 6a/7	100m/330ft	4K@60 4:2:0 24bpp 4K@60 4:4:4 24bpp
HDMI	recommended max length of 3m/10ft	all supported resolutions

10. WARRANTY

Find details of the product's Limited Warranty and other safety, patent, and legal resources at [snapone.com/legal](https://www.snapone.com/legal) or request a paper copy from Customer Service at **866.424.4489**.

11. SUPPORT

For chat and telephone, visit tech.control4.com/s/contactsupport

• Email: TechSupport@SnapOne.com • Visit tech.control4.com for discussions, instructional videos, news, and more.

Copyright ©2021, Snap One, LLC. All rights reserved. Snap One and its respective logos are registered trademarks or trademarks of Snap One, LLC (formerly known as Wirepath Home Systems, LLC), in the United States and/or other countries. 4Store, 4Sight, Control4, Control4 My Home, SnapAV, Araknis Networks, BakPak, Binary, Dragonfly, Episode, Luma, Mockupancy, Nearus, NEEQ, Optiview, OvrC, Pakedge, Sense, Strong, Strong Evolve, Strong VersaBox, SunBriteDS, SunBriteTV, Triad, Truvision, Visualint, WattBox, Wirepath, and Wirepath ONE are also registered trademarks or trademarks of Snap One, LLC. Other names and brands may be claimed as the property of their respective owners. Snap One makes no claim that the information contained herein covers all installation scenarios and contingencies, or product use risks. Information within this specification subject to change without notice.

BINARY®

200-B-660-EXT-444-100AS-B